

CONEXIONES SERIE STANDARD 44

Standard series fittings
Embouts série Standard
Raccordi serie Standard

CONEXIONES SERIE REUSABLES 63

Reusable series fittings
Embouts Récuperables
Raccordi serie Recuperabile

CONEXIONES SERIE BW NO PELAR R12 / 4SP / 4SH 64

BW fittings - no skiving R12 / 4SP / 4SH
Embouts BW sans dénuder R12 / 4SP / 4SH
Raccordi BW - senza pelatura R12 / 4SP / 4SH

CONEXIONES SERIE INTERLOCK 69

Interlock series fittings
Embouts à sertir Interlock
Raccordi serie Interlock

CONEXIONES ALTA PRESIÓN (700 BAR) 77

High pressure 700 Bar fittings
Embouts haute pression 700 Bar
Raccordi altissima pressione (700 Bar)

CONEXIONES SERIE 43 UNA SOLA PIEZA 1SN / R1AT / 2SN / R2AT / R16 / 2SC / 3TE / R17 79

One piece fittings 43 Series 1SN / R1AT / 2SN / R2AT / R16 / 2SC / 3TE / R17
Embouts pré-sertis Série 43 1SN / R1AT / 2SN / R2AT / R16 / 2SC / 3TE / R17
Raccordi un pezzo Serie 43 1SN / R1AT / 2SN / R2AT / R16 / 2SC / 3TE / R17

CONEXIONES SERIE BW UNA SOLA PIEZA R12 / 4SP / 4SH NO PELAR 94

One piece fittings BW series R12 / 4SP / 4SH NO SKIVE
Embouts pré-sertis Série BW R12 / 4SP / 4SH sans dénuder
Raccordi BW - 1 pezzo R12 / 4SP / 4SH senza spellatura

CONEXIONES UNA SOLA PIEZA SERIE BWS 3SP/4SP/R12/4SH NO PELAR 97

One piece fittings BWS SERIES 3SP/4SP/R12/4SH NO SKIVE
Embouts pré-sertis BWS 3SP/4SP/R12/4SH Sans dénuder
Raccordi compatti serie BWS R12/4SP/4SH Serie BW senza spellatura

RACORES PARA TUBERÍA FLEXIBLE

Flexible hose fittings
Embouts à sertir
Raccordi per tubi flessibili



CONEXIONES UNA PIEZA SERIE BW+ R13/R15 NO PELAR 103

One piece fittings BW+ Series R13/R15 No Skive
Embouts R13/R15 Série BW+ Sans denuder
Raccordi R13/R15 Serie BW+ senza spellatura

CONEXIONES PUSH ON 105

PUSH ON series fittings
Embouts PUSH ON
Raccordi serie PUSH ON

SERIE STANDARD

Standard series

TrAle®

TrAle® GOLD

GREENLINE



SAE 100 R6

EN 854 2TE

EN 854 3TE

EN 857 1SC
SUPERSERVICE 15C
155°

EN 853 1SN
SAE 100 R1AT
1SNK

EN 853 2SN
SAE 100 R2AT
2SNK

EN 857 2SC
SUPERSERVICE 25C
155°



DI23



DI2212



SC2112...



SC2112 / DI2212



DI2212



EN 853 2ST
SAE100 R2A

EN 856 4SP
SAE 100 R9R

EN 856 R12
SAE 100



3SP

EN 856 4SP
SAE 100 R9R

EN 856 4SH

EN856 R12
SAE 100

EN 856 R13
SAE 100

SAE 100 R15



DI1224

NO PELAR
NO SKIVE

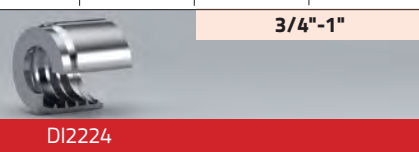

DI2224

3/4"-1"



SAE 100 R7
EN 855

SAE 100 R8
EN 855



Metallic 1 braid

Metallic 2 braid



Ecology 200

Ecology 250



DI23



DI23



DI1224



Z2120...



Smooth PTFE 1 braid

Convuluted PTFE Standard



PTFLEX



Smooth PTFE 1 braid

Smooth PTFE 2 braid

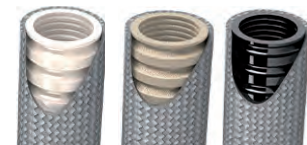

Standard Convuluted PTFE
Fiberglass Convuluted PTFE
Antistatic Convuluted PTFE



28040

NEW



28041

NEW



21041



21040



21045



21041



SERIE BW NO PELAR

BW Series no skive



EN 856 4SP SAE 100	EN 856 4SH	EN 856 R12 SAE 100	EN 856 R13 SAE 100	EN 856 R13 SAE 100	SAE 100 R15
AC68010	AC68010	AC68010	AC69010	AC69010	AC69010
3/4"-1"			1" 1/4-1" 1/2-2"		

SERIE INTERLOCK

Interlock series



EN 856 4SH	EN 856 R13 SAE 100	SAE 100 R15
A61010	A61010 61010...	A61010 61010...

CONEXIONES SERIE STANDARD

Standard series fittings
 Embouts série Standard
 Raccordi serie Standard

Casquillos para prensar ▪ Crimping ferrules ▪ Jupes à sertir ▪ Boccole a pressare | 44



Conexiones BSP/BSPT ▪ BSP/BSPT Fittings ▪ Embouts BSP/BSPT ▪ Raccordi BSP/BSPT | 46



Conexiones JIC 37º ▪ JIC 37º Fittings ▪ Embouts JIC 37º ▪ Raccordi JIC 37º | 50



Conexiones Métricas DIN 2353 ▪ Metric fittings DIN 2353 ▪ Embouts Métriques DIN 2353 ▪ Raccordi Metrici DIN 2353 | 52

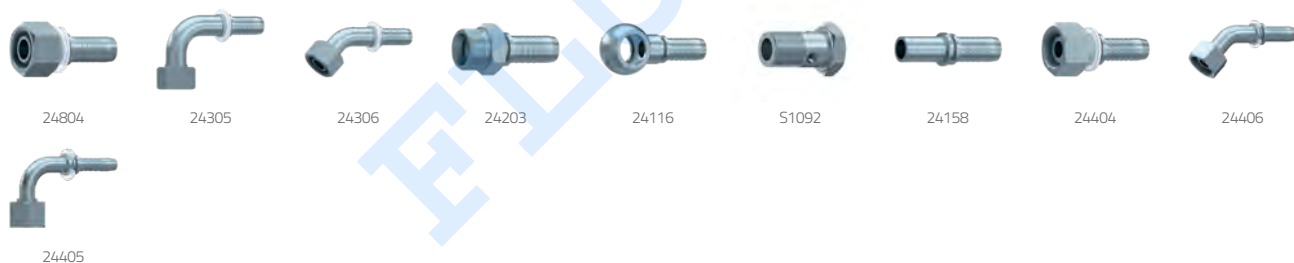

Conexiones NPT/NPSM ▪ NPT/NPSM Fittings ▪ Embouts NPT/NPSM ▪ Raccordi NPT/NPSM | 56



Conexiones Serie Japonesa ▪ Fittings Japanese Serie ▪ Embouts Série Japonaise ▪ Raccordi Serie Giapponese | 56



Conexiones Métricas Serie Francesa ▪ Metric fittings French Serie ▪ Embouts Métriques Série Française ▪ Raccordi Metrici Serie Francese | 57

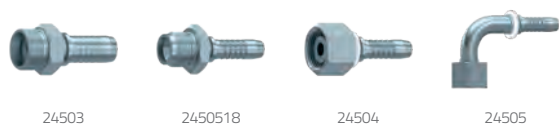

CONEXIONES SERIE STANDARD

Standard series fittings
 Embouts série Standard
 Raccordi serie Standard

Conexiones ORFS ▪ ORFS Fittings ▪ Embouts ORFS ▪ Raccordi ORFS | 58



Bridas SAE 3000/6000/9000 PSI ▪ 3000/6000 PSI SAE Flanges ▪ Brides SAE 3000/6000 PSI ▪ Flangia SAE 3000/6000 PSI | 59



Bridas fijación SAE ▪ SAE Flanges ▪ Brides SAE ▪ Flangia SAE | 61



Racores para hidrolavadoras ▪ Karcher fittings ▪ Embouts Karcher ▪ Raccordi per idropultrici | 62



Conexiones CO2 ▪ CO2 Fittings ▪ Embouts CO2 ▪ Raccordi CO2 | 62



FLUIDAL

CONEXIONES SERIE REUSABLES

Reusable series fittings
Embouts Récuperables
Raccordi serie Recuperabile

Casquillos ▪ Ferrules ▪ Jupes ▪ Boccole recuperabili

| 63

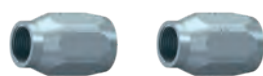

A1G-...R1T

A1G-...R2T

Conexiones ▪ Fittings ▪ Embouts ▪ Raccordi recuperabili

| 63



A3G

A90G

A2G

AE

A3J

A2J

FLUIDAL

CONEXIONES SERIE BW NO PELAR R12 / 4SP / 4SH

BW fittings - no skiving R12 / 4SP / 4SH
 Embouts BW sans dénuder R12 / 4SP / 4SH
 Raccordi BW - senza pelatura R12 / 4SP / 4SH

Casquillos serie BW/BW+ ▪ Ferrules BW/BW+ series ▪ Jupes à sertir BW/BW+ ▪ Boccole pressare serie BW/BW+ | 64

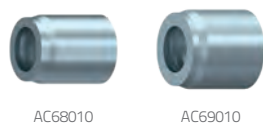

AC68010

AC69010

Conexiones BSP ▪ BSP Fittings ▪ Embouts BSP ▪ Raccordi BSP | 64

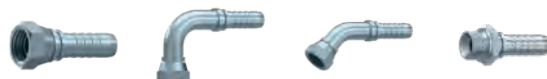

66110

66117

66118

66112

Conexiones JIC 37º ▪ JIC 37º Fittings ▪ Embouts JIC 37º ▪ Raccordi JIC 37º | 65



66140

66242

66138

66139

Conexiones Métricas DIN 2353 ▪ Metric fittings ▪ Embouts Métriques ▪ Raccordi Metrici | 65



66205

66206

66203

66204

Bridas SAE 3000/6000 PSI ▪ SAE Flanges 3000/6000 PSI ▪ Brides SAE 3000/6000 PSI ▪ Flangia SAE 3000/6000 PSI | 66



66182

66183

66184

66282

66283

66284

Conexiones ORFS ▪ ORFS Fittings ▪ Embouts ORFS ▪ Raccordi ORFS | 67



66901

66907

66908

CONEXIONES SERIE INTERLOCK

Interlock series fittings
 Embouts à sertir Interlock
 Raccordi serie Interlock

Casquillos ▪ Crimping ferrules ▪ Jupes ▪ Boccole a pressare | 69



A61010

61010

Conexiones BSP ▪ BSP Fittings ▪ Embouts BSP ▪ Raccordi BSP | 69



64100

64107

64108

64112

64161

64500

64507

64508

Conexiones JIC 37º ▪ JIC 37º Fittings ▪ Embouts JIC 37º ▪ Raccordi JIC 37º | 71



64142

64138

64139

64140

64542

64538

64539

Conexiones Métricas DIN 2353 ▪ Metric fittings DIN 2353 ▪ Embouts Métriques DIN 2353 ▪ Raccordi Metrici DIN 2353 | 72



64204

64206

64205

64203

Racores para martillo ▪ Fittings for hammer ▪ Embouts pour marteau ▪ Raccordi per martello | 72



NAM

Conexiones ORFS ▪ ORFS fittings ▪ Embouts ORFS ▪ Raccordi ORFS | 73



64900

64908

64907

Bridas SAE 3000/6000 PSI ▪ 3000/6000 PSI SAE Flanges ▪ Embouts brides SAE 3000/6000 PSI ▪ Flangia SAE 3000/6000 PSI | 74



64182

64183

64184

64282

64283

64284

Bridas 9000 PSI ▪ 9000 PSI Flanges ▪ Embouts brides 9000 PSI ▪ Flangia 9000 PSI | 75



64382

64384

64383

Bridas Poclairn ▪ Poclairn flanges ▪ Embouts brides Poclairn ▪ Flangia Poclairn | 76



64801

44805

44807

64802

44806

CONEXIONES ALTA PRESIÓN (700 BAR)

High pressure 700 Bar fittings
Embouts haute pression 700 Bar
Raccordi altissima pressione (700 Bar)

Casquillos ▪ Ferrules ▪ Jupes à sertir ▪ Boccole

| 77



MT700



71012

Conexiones ▪ Fittings ▪ Embouts ▪ Raccordi

| 77



74100



74112



74161

FLUIDAL

CONEXIONES SERIE 43 UNA SOLA PIEZA 1SN / R1AT / 2SN / R2AT / R16 / 2SC / 3TE / R17

One piece fittings 43 Series 1SN / R1AT / 2SN / R2AT / R16 / 2SC / 3TE / R17
 Embouts pré-sertis Série 43 1SN / R1AT / 2SN / R2AT / R16 / 2SC / 3TE / R17
 Raccordi un pezzo Serie 43 1SN / R1AT / 2SN / R2AT / R16 / 2SC / 3TE / R17

Casquillos para racores de una sola pieza ▪ Ferrules for one piece fittings ▪ Jupes pour embouts pré-sertis ▪ Boccole per raccordi un pezzo | 79

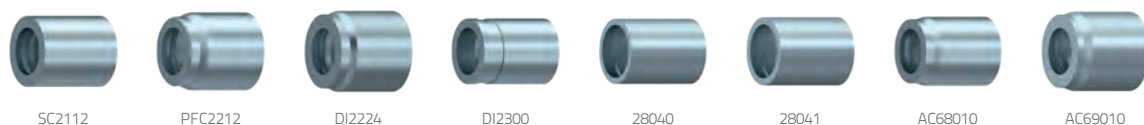

5C2112 PFC2212 DI2224 DI2300 28040 28041 AC68010 AC69010

Conexiones una sola pieza JIC 37º ▪ One piece JIC 37º fittings ▪ Embouts pré-sertis JIC 37º ▪ Raccordi un pezzo JIC 37º | 81



28142 28140 28242 28138 28139

Conexiones una sola pieza NPT-NPSM ▪ One piece NPT-NPSM fittings ▪ Embouts pré-sertis NPT-NPSM ▪ Raccordi un pezzo NPT-NPSM | 82



28161 28261

Conexiones una sola pieza ORFS ▪ One piece ORFS fittings ▪ Embouts pré-sertis ORFS ▪ Raccordi un pezzo ORFS | 83



28900 28907 28912 28908

Conexiones una sola pieza Bridas SAE 3000/6000 PSI ▪ One piece SAE Flanges fittings 3000/6000 PSI ▪ Embouts pré-sertis Brides SAE 3000/6000 PSI ▪ Raccordi un pezzo Flange SAE 3000/6000 PSI | 84

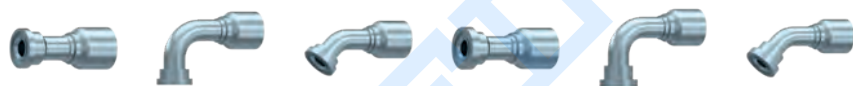

28182 28183 28184 28282 28283 28284

Conexiones una sola pieza Bridas SAE 9000 PSI ▪ One piece SAE Flanges fittings 9000 PSI ▪ Embouts pré-sertis Brides SAE 9000 PSI ▪ Raccordi un pezzo Flange SAE 9000 PSI | 85



48282 48283 48284

Conexiones una sola pieza Métricas ▪ One piece Metric fittings ▪ Embouts pré-sertis Métriques ▪ Raccordi un pezzo Metrici | 86



28804 28203 28305 28306 28116 28404 28405 28406 28158



28804 28300

CONEXIONES SERIE 43 UNA SOLA PIEZA 1SN / R1AT / 2SN / R2AT / R16 / 2SC / 3TE / R17

One piece fittings 43 Series 1SN / R1AT / 2SN / R2AT / R16 / 2SC / 3TE / R17
Embouts pré-sertis Série 43 1SN / R1AT / 2SN / R2AT / R16 / 2SC / 3TE / R17
Raccordi un pezzo Serie 43 1SN / R1AT / 2SN / R2AT / R16 / 2SC / 3TE / R17

Conexiones una sola pieza BSP - BSPT ▪ One piece BSP - BSPT fittings ▪ Embouts pré-sertis BSP - BSPT ▪
Raccordi un pezzo BSP - BSPT

89



FLUIDAL

CONEXIONES SERIE BW UNA SOLA PIEZA R12 / 4SP / 4SH NO PELAR

One piece fittings BW series R12 / 4SP / 4SH NO SKIVE
 Embouts pré-sertis Série BW R12 / 4SP / 4SH sans dénuder
 Raccordi BW - 1 pezzo R12 / 4SP / 4SH senza spellatura

Conexiones JIC 37º ▪ JIC 37º Fittings ▪ Embouts JIC 37º ▪ Raccordi JIC 37º | 94



68140

68242

68138

68139

Conexiones ORFS ▪ ORFS Fittings ▪ Embouts ORFS ▪ Raccordi ORFS | 94

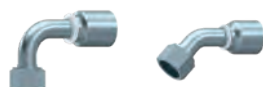

68907

68908

Bridas SAE 3000/6000 PSI ▪ SAE Flanges 3000/6000 PSI ▪ Brides SAE 3000/6000 PSI ▪ Flangia SAE 3000/6000 PSI | 95



68182

68183

68184

68282

68283

68284

Conexiones Métricas DIN 2353 ▪ Metric fittings ▪ Embouts Métriques ▪ Raccordi Metrici DIN 2353 | 96



68205

68206

68203

Conexiones BSP ▪ BSP Fittings ▪ Embouts BSP ▪ Raccordi BSP | 96

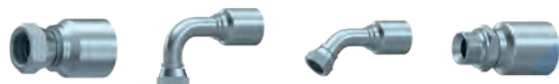

68110

68107

68108

68112

CONEXIONES UNA SOLA PIEZA SERIE BWS 3SP/4SP/R12/4SH NO PELAR

One piece fittings BWS SERIES 3SP/4SP/R12/4SH NO SKIVE

Emboutis pré-sertis BWS 3SP/4SP/R12/4SH Sans dénuder

Raccordi compatti serie BWS R12/4SP/4SH Serie BW senza spellatura

Conexiones una sola pieza JIC 37º ▪ One piece JIC 37º fittings ▪ Embouts pré-sertis JIC 37º ▪ Raccordi compatti JIC 37º | 97



58140 58142 58138 58139 58242

Conexiones una sola pieza ORFS ▪ One piece ORFS fittings ▪ Embouts pré-sertis ORFS ▪ Raccordi compatti ORFS | 98



58900 58907 58908 58912

Conexiones una sola pieza NPT-NPSM ▪ One piece NPT-NPSM fittings ▪ Embouts pré-sertis NPT-NPSM ▪ Raccordi compatti NPT-NPSM | 98



58261 58161

Conexiones una sola pieza Bridas SAE ▪ One piece SAE Flanges fittings ▪ Embouts pré-sertis Brides SAE ▪ Raccordi compatti Flange SAE | 99



58182 58183 58184 58282 58283 58284

Conexiones una sola pieza BSP ▪ One piece BSP fittings ▪ Embouts pré-sertis BSP ▪ Raccordi compatti BSP | 100



58110 58117 58118 58112 58400 58200

Conexiones una sola pieza Métricas ▪ One piece Metric fittings ▪ Embouts pré-sertis Métriques ▪ Raccordi compatti Metrici | 101



58804 58305 58306 58203

CONEXIONES UNA PIEZA SERIE BW+ R13/R15 NO PELAR

One piece fittings BW+ Series R13/R15 No Skive

Embouts R13/R15 Série BW+ Sans denuder

Raccordi R13/R15 Serie BW+ senza spellatura

Conexiones JIC 37º ▪ JIC 37º fittings ▪ Embouts JIC 37º ▪ Raccordi JIC 37º

| 103

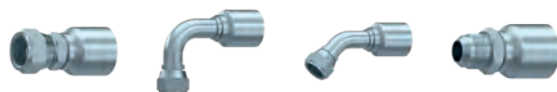

69242

69138

69139

69140

Conexiones ORFS ▪ ORFS fittings ▪ Embouts ORFS ▪ Raccordi ORFS

| 103



69901

69907

69908

Bridas SAE ▪ SAE Flanges ▪ Brides SAE ▪ Flange SAE

| 104



69282

69283

69284

Conexiones BSP ▪ BSP fittings ▪ Embouts BSP ▪ Raccordi BSP

| 104



69112

69110

69117

69118

FLUIDAL

CONEXIONES PUSH ON

PUSH ON series fittings

Embouts PUSH ON

Raccordi serie PUSH ON

Conexiones PUSH ON BSP ▪ PUSH ON BSP series fittings ▪ Embouts PUSH ON BSP ▪ Raccordi serie PUSH ON BSP | 105



39100

39112

Conexiones Push-On JIC 37° ▪ PUSH ON JIC 37° series fittings ▪ Embouts PUSH ON JIC 37° ▪ Raccordi serie PUSH ON JIC 37° | 105



39142

39140

Conexiones Push-On NPT ▪ PUSH ON NPT series fittings ▪ Embouts PUSH ON NPT ▪ Raccordi serie PUSH ON NPT | 105



39161

Conexiones Push-On Métricas DIN 2383 ▪ PUSH ON Metrics series fittings ▪ Embouts PUSH ON Métrique ▪ Raccordi serie PUSH ON Metrica | 105



39804

39203

FLUIDAL

CONEXIONES SERIE STANDARD

Standard series fittings
Embouts série Standard
Raccordi serie Standard

Casquillos R1AT/R2AT/1SN/2SN/2SC/R16/3TE

Ferrules R1AT/R2AT/1SN/2SN/2SC/R16/3TE

Jupes à sertir R1AT/R2AT/1SN/2SN/2SC/R16/3TE

Boccole a pressare per R1AT/R2AT/1SN/2SN/2SC/R16/3TE



DN	Referencia Part n°	€
3/16"	DI221200300	1,39
1/4"	DI221200400	1,16
5/16"	DI221200501	1,16
3/8"	DI221200600	1,33
1/2"	DI221200800	1,57
5/8"	DI221201000	2,12
3/4"	DI221201200	3,11
1"	DI221201600	6,46
1"1/4	DI221202000	18,77
1"1/2	DI221202400	27,08
2"	DI221203200	39,06
2"1/2	DI221204000	47,35
3"	DI221204800	57,53

Casquillos R4

Ferrules R4

Jupes à sertir R4

Boccole a pressare per R4



DN	Referencia Part n°	€
3/4"	DI221201200R4	8,85

Para otros tamaños, consultar tabla de prensado en nuestra web./ For other sizes, please check out the crimping table on our website. / Pour les autres dimensions, voir tableau de sertissage disponible sur notre site web. / Per altre dimensioni, vedere tabella di pressatura nel ns. sito web

Casquillos R6, R7, R8 y malla metálica

Ferrules SAE 100 R6, R7, R8 and steel braid

Jupes à sertir R6, R7, R8 et tresse métallique

Boccole a pressare per SAE R6, R7, R8 e Treccia Metallica



DN	Referencia Part n°	€
1/8"	DI2300200	1,25
3/16"	DI2300300	1,01
1/4"	DI2300400	1,03
5/16"	DI2300500	1,75
3/8"	DI2300600	1,55
1/2"	DI2300800	2,17
5/8"	DI2301000	3,40
3/4"	DI2301200	5,79
1"	DI2301600	9,52

Casquillos 1SC/1SN/2SC/R6/2TE

Ferrules 1SC/1SN/2SC/R6/2TE

Jupes à sertir 1SC/1SN/2SC/R6/2TE

Boccole a pressare per 1SC/1SN/2SC/R6/2TE

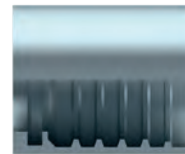

DN	Referencia Part n°	€
1/4"	SC21120400	1,49
5/16"	SC21120500	1,43
3/8"	SC21120600	1,63
1/2"	SC21120800	2,49
5/8"	SC21121000	3,38
3/4"	SC21121200	4,89
1"	SC21121600	7,58

Casquillos R2A/R9R/2ST/4SP

Ferrules R2A/R9R/2ST/4SP

Jupes à sertir R2A/R9R/2ST/4SP

Boccole a pressare per R2A/R9R/2ST/4SP



DN	Referencia Part n°	€
1/4"	DI122400400	1,61
5/16"	DI122400500	1,99
3/8"	DI122400600	1,71
1/2"	DI122400800	2,86
5/8"	DI122401000	3,80
3/4"	DI122401200	5,55
1"	DI122401600	8,17
1"1/4	DI122402000	24,20
1"1/2	DI122402400	22,66
2"	DI122403200	41,20

Casquillos R12/3SP/4SP/4SH no pelar

Ferrules R12/3SP/4SP/4SH non skive

Jupes à sertir R12/3SP/4SP/4SH sans dénudage

Boccole a pressare per R12/ 3SP/4SP/4SH senza spellatura



DN	Referencia Part n°	€
3/8"	DI222400600	2,27
1/2"	DI222400800	2,95
5/8"	DI222401000	4,30
3/4"	DI222401200	7,33
1"	DI222401600	8,72
1"1/4	DI222402000	17,51
1"1/2	DI222402400	33,40
2"	DI222403200	53,46

■ **CASQUILLO:** Reduce costes y tiempo de montaje

■ **FERRULES:** Simplify assembly and save money



Consulta en nuestra ficha técnica datos | Check our technical sheet for data

NO PELAR | NO SKIVING
3SP | 4SP | R12 | 4SH

ESPIGA STANDARD | STANDARD SERIES



DI2224...

CONEXIONES SERIE STANDARD

Standard series fittings
Embouts série Standard
Raccordi serie Standard

Casquillos PTFE Liso alta presión SAE 100 R14

Ferrules for Smooth PTFE SAE 100 R14

Jupes à sertir pour PTFE Lisse haute pression SAE 100 R14

Boccole a pressare per tubo al PTFE Liscio alta pressione SAE 100 R14



DN	Referencia Part n°	€
1/8"	210400100	1,50
3/16"	210400300	1,66
1/4"	210400400	1,21
5/16"	210400500	1,64
3/8"	210400600	1,29
1/2"	210400800	2,01
5/8"	210401000	2,59
3/4"	210401200	3,43
1"	210401600	6,06

Casquillos PTFE liso doble malla alta presión

Ferrules for Smooth PTFE high pressure hose with two braids

Jupes à sertir pour PTFE Lisse double tresse haute pression

Boccole a pressare per tubo al PTFE Liscio doppia treccia alta pressione

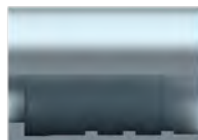

DN	Referencia Part n°	€
1/4"	210450400	1,25
3/8"	210450600	1,56

Para otros tamaños, consultar tabla de prensado en nuestra web. / For other sizes, please check out the crimping table on our website. / Pour les autres dimensions, voir tableau de sertissage disponible sur notre site web. / Per altre dimensioni, vedere tabella di pressatura nel ns. sito web

Casquillos PTFE Corrugado alta presión

Ferrules for Corrugated PTFE

Jupes à sertir PTFE Convoluté haute pression

Boccole a pressare per tubo al PTFE Corrugato alta pressione

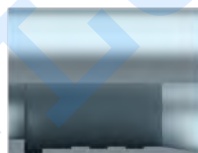

DN	Referencia Part n°	€
1/4"	210410400	1,64
3/8"	210410600	1,89
1/2"	210410800	2,11
5/8"	210411000	3,69
3/4"	210411201	3,78
1"	210411600	6,88
1"1/4	210412001	13,94
1" 1/2	210412400	17,56
2"	210413200	30,11

Casquillos PTFE Liso alta presión SAE 100 R14 perfil liso

NEW

Ferrules for Smooth PTFE SAE 100 R14 smooth surface

Jupes à sertir pour PTFE Lisse haute pression SAE 100 R14 surface lisse

Boccole a pressare per tubo al PTFE Liscio alta pressione SAE 100 R14 profilo liscio

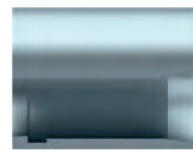

DN	Referencia Part n°	€
1/4"	280400400	1,33
5/16"	280400500	1,70
3/8"	280400600	1,53
1/2"	280400800	2,50
5/8"	280401000	2,85

Casquillos PTFE Corrugado alta presión perfil liso

NEW

Ferrules for Corrugated PTFE smooth surface

Jupes à sertir PTFE Convoluté haute pression surface lisse

Boccole a pressare per tubo al PTFE Corrugato alta pressione profilo liscio

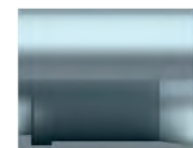

DN	Referencia Part n°	€
1/4"	280410400	1,41
3/8"	280410600	1,61
1/2"	280410800	2,02
5/8"	280411000	3,17
3/4"	280411200	3,62



FACIL MONTAJE
EASY ASSEMBLY

VALIDO PARA CONEXIONES DE 1 Y 2 PIEZAS
SUITABLE FOR 1 & 2 PIECE FITTINGS

NEW

CASQUILLOS PERFIL LISO
FERRULES WITH SMOOTH PROFILE



CONEXIONES SERIE STANDARD

Standard series fittings
Emboutis série Standard
Raccordi serie Standard

Hembras giratorias rectas BSP cono 60°

BSP Swivel female 60° cone

Femelle tournante gaz cyl BSP 60°

Femmina diritta BSP sede 60°



DN	ROSCA THREAD	Referencia Part n°	€
1/8"	1/8" BSP	241000202	1,68
3/16"	1/8" BSP	241000203	1,61
1/4"	1/8" BSP	241000204	1,95
3/16"	1/4" BSP	241000403	2,03
1/4"	1/4" BSP	241000404	1,62
5/16"	1/4" BSP	241000405	2,08
3/8"	1/4" BSP	241000406	2,24
1/4"	3/8" BSP	241000604	2,40
5/16"	3/8" BSP	241000605	2,23
3/8"	3/8" BSP	241000606	2,09
1/2"	3/8" BSP	241000608	2,63
1/4"	1/2" BSP	241000804	3,02
3/8"	1/2" BSP	241000806	2,86
1/2"	1/2" BSP	241000808	2,88
5/8"	1/2" BSP	241000810	3,61
1/2"	5/8" BSP	241001008	4,38
5/8"	5/8" BSP	241001010	3,80
1/2"	3/4" BSP	241001208	4,51
5/8"	3/4" BSP	241001210	4,57
3/4"	3/4" BSP	241001212	4,78
3/4"	1" BSP	241001612	8,71
1"	1" BSP	241001616	8,45
2"	2"1/2 BSP	241004032	75,12
2"1/2	2"1/2 BSP	241004040	75,12
3"	3" BSP	241004848	86,66

Para medidas de 1" 1/4, 1" 1/2 y 2" ver con junta / For sizes of 1" 1/4, 1" 1/2 y 2" see with o'ring / Pour les dimensions de 1" 1/4, 1" 1/2 y 2" voir avec o'ring / Per quelli di 1" 1/4, 1" 1/2 y 2" vedere con o'ring

Hembras giratorias 45° BSP cono 60°

BSP Swivel female 60° cone (45° Elbow)

Coude 45° femelle tournante gaz cyl BSP 60°

Femmina a 45° BSP sede 60°



DN	ROSCA THREAD	Referencia Part n°	€
3/16"	1/8" BSP	241080203	3,54
1/4"	1/8" BSP	241080204	2,42
3/16"	1/4" BSP	241080403	3,48
1/4"	1/4" BSP	241080404	2,73
1/4"	3/8" BSP	241080604	3,35
5/16"	3/8" BSP	241080605	4,08
3/8"	3/8" BSP	241080606	3,81
3/8"	1/2" BSP	241080806	5,28
1/2"	1/2" BSP	241080808	5,28
1/2"	5/8" BSP	241081008	8,28
5/8"	5/8" BSP	241081010	8,28
5/8"	3/4" BSP	241081210	9,98
3/4"	3/4" BSP	241081212	10,65
3/4"	1" BSP	241081612	17,85
1"	1" BSP	241081616	16,63

Para aquellas mayores de 1" ver con junta / For those bigger than 1" see with o'ring / Pour ceux plus grand que 1" voir avec o'ring / Per quelli più grandi di 1" vedere con o'ring

Hembras giratorias 90° BSP cono 60°

BSP Swivel female 60° cone (90° Elbow)

Coude 90° femelle tournante gaz cyl BSP 60°

Femmina a 90° BSP sede 60°



DN	ROSCA THREAD	Referencia Part n°	€
3/16"	1/8" BSP	241070203	3,22
1/4"	1/8" BSP	241070204	2,72
3/16"	1/4" BSP	241070403	3,14
1/4"	1/4" BSP	241070404	2,69
1/4"	3/8" BSP	241070604	3,64
5/16"	3/8" BSP	241070605	3,87
3/8"	3/8" BSP	241070606	3,62
1/4"	1/2" BSP	241070804	5,63
3/8"	1/2" BSP	241070806	4,54
1/2"	1/2" BSP	241070808	4,78
1/2"	5/8" BSP	241071008	8,95
5/8"	5/8" BSP	241071010	8,09
1/2"	3/4" BSP	241071208	8,89
5/8"	3/4" BSP	241071210	9,28
3/4"	3/4" BSP	241071212	8,83
3/4"	1" BSP	241071612	15,92
1"	1" BSP	241071616	16,50

Para aquellas mayores de 1" ver con junta / For those bigger than 1" see with o'ring / Pour ceux plus grand que 1" voir avec o'ring / Per quelli più grandi di 1" vedere con o'ring

Hembras giratorias rectas BSP cono 60° con junta tórica

BSP Swivel female 60° with o'ring

Femelle tournante droit gaz cyl BSP 60° + o'ring

Femmina diritta BSP sede 60° con o'ring



DN	ROSCA THREAD	Referencia Part n°	€
1/4"	1/4" BSP	241100404	2,02
3/8"	3/8" BSP	241100606	2,66
1/2"	1/2" BSP	241100808	3,37
5/8"	5/8" BSP	241101010	5,33
5/8"	3/4" BSP	241101210	5,72
3/4"	3/4" BSP	241101212	5,10
1"	1" BSP	241101616	11,19
1"	1"1/4 BSP	241102016	19,43
1"1/4	1"1/4 BSP	241102020	20,34
1"1/4	1"1/2 BSP	241102420	27,16
1"1/2	1"1/2 BSP	241102424	26,44
1"1/2	2" BSP	241103224	47,76
2"	2" BSP	241103232	48,05

CONEXIONES SERIE STANDARD

Standard series fittings
Embouts série Standard
Raccordi serie Standard

Hembras giratorias 45° BSP cono 60° con junta tórica

BSP Swivel female 60° cone with o'ring (45° Elbow)

Coude 45° femelle tournante gaz cyl BSP 60° + o'ring

Femmina a 45° BSP sede 60° con o'ring



DN	ROSCA THREAD	Referencia Part n°	€
3/8"	3/8" BSP	241180606	4,27
1/2"	1/2" BSP	241180808	5,40
5/8"	5/8" BSP	241181010	8,56
3/4"	3/4" BSP	241181212	16,23
1"	1" BSP	241181616	17,89
1"1/4	1"1/4 BSP	241182020	26,17
1"1/2	1"1/2 BSP	241182424	35,84
2"	2" BSP	241183232	57,15

*Hasta fin de existencias./ *Until end of stock. / *Jusqu'à la fin du stock./ *Fino ad esaurimento scorta.

Hembras giratorias BSP 60° doble hexagono

BSP Swivel female 60° cone double hex.

Femelle tournante BSP cône 60° double hexagonal

Femmina diritta BSP sede 60° doppio esagono



DN	ROSCA THREAD	Referencia Part n°	€
1/4"	1/4" BSP	244000404	2,98
5/16"	3/8" BSP	244000605	3,39
3/8"	3/8" BSP	244000606	3,64
1/2"	1/2" BSP	244000808	4,47
3/4"	3/4" BSP	244001212	9,25
1"	1" BSP	244001616	12,33
1"1/4	1"1/4 BSP	244002020	26,13
1"1/2	1"1/2 BSP	244002424	39,52
2"	2" BSP	244003232	68,58

Hembras giratorias 90° BSP cono 60° con junta tórica

BSP Swivel female 60° cone with o'ring (90° Elbow)

Coude 90° femelle tournante gaz cyl BSP 60° + o'ring

Femmina a 90° BSP sede 60° con o'ring



DN	ROSCA THREAD	Referencia Part n°	€
1/4"	1/4" BSP	241170404*	4,05
3/8"	3/8" BSP	241170606	5,04
1/2"	1/2" BSP	241170808	7,06
5/8"	5/8" BSP	241171010	9,76
3/4"	3/4" BSP	241171212	11,83
1"	1" BSP	241171616	20,17
1"	1"1/4 BSP	241172016	32,35
1"1/4	1"1/4 BSP	241172020	36,61
1"1/4	1"1/2 BSP	241172420	38,23
1"1/2	1"1/2 BSP	241172424	42,48
2"	2" BSP	241173232	104,78

Disponibles en diámetros 2" 1/2 - 3"
Larger diameters available 2" 1/2 - 3"

P-19



EN 853 2SN / SAE 100 R2AT
MS3511...

P-42



R1AT/R2AT/1SN/2SN/2SC/R16/3TE BSP (60°)
D12212...

P-44



24100...

P-286



A1020... | A1010...

P-59



3000PSI
24182...

Consulta en nuestra ficha técnica. | Check our technical sheet for data options.

CONEXIONES SERIE STANDARD

Standard series fittings
Embouts série Standard
Raccordi serie Standard

Hembras giratorias rectas BSP asiento plano

BSP Swivel female flat seat

Femelle tournante fond plat BSP

Femmina diritta BSP sede piana



DN	ROSCA THREAD	Referencia Part n°	€
1/4"	1/4" BSP	242000404	2,10
5/16"	3/8" BSP	242000605	2,86
3/8"	3/8" BSP	242000606	2,91
3/8"	1/2" BSP	242000806	2,98
1/2"	1/2" BSP	242000808	3,01
1/2"	3/4" BSP	242001208	5,76
3/4"	3/4" BSP	242001212	6,24
1"	1" BSP	242001616	10,11
1" 1/4	1" 1/4 BSP	242002020	21,78
1" 1/2	1" 1/2 BSP	242002424	29,08

Macho rosca cilíndrica BSP asiento plano

BSP Male flat seat

Mâle fixe gaz cyl fond plat

Maschio BSP cilindrico sede piana



DN	ROSCA THREAD	Referencia Part n°	€
1/4"	1/4" BSP	242120404	2,99
3/8"	3/8" BSP	242120606	3,94
3/8"	1/2" BSP	242120806	5,51
1/2"	1/2" BSP	242120808	5,37
3/4"	3/4" BSP	242121212	8,17
1"	1" BSP	242121616	14,85

Hembras giratorias 90° BSP asiento plano

BSP Swivel female flat seat (90° Elbow)

Embout à sertir coude 90° femelle tournante fond plat BSP

Femmina a 90° BSP sede 60° sede piana



DN	ROSCA THREAD	Referencia Part n°	€
1/4"	1/4" BSP	242070404	3,44
3/8"	3/8" BSP	242070606	4,68
1/2"	1/2" BSP	242070808	4,76
3/4"	3/4" BSP	242071212	12,51
1"	1" BSP	242071616	22,00

Hembras giratorias 90° BSP cono 60° (forja)

BSP Swivel female 60° cone forge (90° Elbow)

Coude 90° femelle tournante forge gaz cyl BSP 60°

Femmina a 90° BSP sede 60° (forgiata)



DN	ROSCA THREAD	Referencia Part n°	€
1/4"	1/4" BSP	241270404	4,52
5/16"	3/8" BSP	241270605	4,68
3/8"	3/8" BSP	241270606	5,62
3/8"	1/2" BSP	241270806	5,86
1/2"	1/2" BSP	241270808	7,30
5/8"	3/4" BSP	241271210	9,61
3/4"	3/4" BSP	241271212	11,90

Macho rosca cilíndrica BSP cono 60°

BSP Male parallel 60° cone

Mâle fixe gaz cyl BSP 60°

Maschio BSP cilindrico sede 60°



DN	ROSCA THREAD	Referencia Part n°	€
3/16"	1/8" BSP	241120203	1,45
1/4"	1/8" BSP	241120204	1,82
1/8"	1/4" BSP	241120402	6,62
3/16"	1/4" BSP	241120403	3,94
1/4"	1/4" BSP	241120404	1,73
3/8"	1/4" BSP	241120406	2,82
1/4"	3/8" BSP	241120604	2,52
5/16"	3/8" BSP	241120605	2,43
3/8"	3/8" BSP	241120606	2,23
1/2"	3/8" BSP	241120608	3,08
1/4"	1/2" BSP	241120804	3,97
3/8"	1/2" BSP	241120806	3,43
1/2"	1/2" BSP	241120808	3,05
1/2"	5/8" BSP	241121008	6,30
5/8"	5/8" BSP	241121010	5,26
1/2"	3/4" BSP	241121208	6,16
5/8"	3/4" BSP	241121210	6,28
3/4"	3/4" BSP	241121212	5,06
3/4"	1" BSP	241121612	12,00
1"	1" BSP	241121616	8,76
1"	1" 1/4 BSP	241122016	23,10
1" 1/4	1" 1/4 BSP	241122020	22,84
1" 1/2	1" 1/2 BSP	241122424	24,20
2"	2" BSP	241123232	51,30

Macho rosca cónica BSPT

BSPT Male tapered

Mâle fixe gaz conique BSPT

Maschio BSPT conico



DN	ROSCA THREAD	Referencia Part n°	€
3/16"	1/8" BSPT	241140203	1,48
1/4"	1/8" BSPT	241140204	1,40
1/4"	1/4" BSPT	241140404	1,40
1/4"	3/8" BSPT	241140604	2,24
5/16"	3/8" BSPT	241140605	1,95
3/8"	3/8" BSPT	241140606	2,08
3/8"	1/2" BSP	241140806	2,67
1/2"	1/2" BSPT	241140808	2,87
5/8"	3/4" BSPT	241141210	5,88
3/4"	3/4" BSPT	241141212	6,05
3/4"	1" BSPT	241141612	10,08
1"	1" BSPT	241141616	11,23
1"	1" 1/4 BSPT	241142016	18,23
1" 1/4	1" 1/4 BSPT	241142020	21,21
1" 1/2	1" 1/2 BSPT	241142424	20,80
2"	2" BSPT	241143232	51,91

CONEXIONES SERIE STANDARD

Standard series fittings

Embouts série Standard

Raccordi serie Standard

Orientable BSP

Banjo BSP

Embout Banjo droit gaz

Raccordo ad occhio BSP



DN	∅	Referencia Part n°	€
3/16"	1/4" BSP	241110403	3,36
1/4"	1/4" BSP	241110404	2,51
5/16"	1/4" BSP	241110405	3,09
3/8"	1/4" BSP	241110406	3,09
1/4"	3/8" BSP	241110604	3,76
5/16"	3/8" BSP	241110605	4,08
3/8"	3/8" BSP	241110606	3,57
1/2"	3/8" BSP	241110608	3,66
3/8"	1/2" BSP	241110806	5,31
1/2"	1/2" BSP	241110808	5,36
5/8"	5/8" BSP	241111010	12,57
1/2"	3/4" BSP	241111208	11,86
5/8"	3/4" BSP	241111210	15,13
3/4"	3/4" BSP	241111212	13,04
1"	1" BSP	241111616	33,15

Tornillo orientable simple BSP

BSP bolt for Banjo

Vis creuse simple pour banjo filetage gaz BSP

Bullone forato BSP

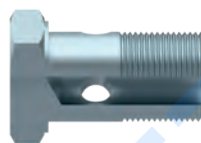

ROSCA THREAD	Referencia Part n°	€
1/8" BSP	A109002	1,31
1/4" BSP	A109004	1,19
3/8" BSP	A109006	1,50
1/2" BSP	A109008	2,11
5/8" BSP	A109010	3,14
3/4" BSP	A109012	4,02
1" BSP	A109016	7,88
1 1/4" BSP	A109020	23,68

*Ver precios en p.302 (ADAPTADORES BSP) / *See prices in p.302 (BSP ADAPTORS) / *Prix à la p.302 (ADAPTEURS BSP) / *Vedere prezzi p.302 (ADATTATORI BSP)

CONEXIONES SERIE STANDARD

Standard series fittings
Embouts série Standard
Raccordi serie Standard

Hembras giratorias rectas JIC 37°

JIC Swivel female 37° cone

Femelle tournante droite JIC cône 37°

Femmina diritta JIC 37°



DN	ROSCA THREAD	Referencia Part n°	€
3/16"	7/16" 20h UNF	241420703	1,86
1/4"	7/16" 20h UNF	241420704	1,67
1/4"	1/2" 20h UNF	241420804	1,92
5/16"	1/2" 20h UNF	241420805	2,55
1/4"	9/16" 18h UNF	241420904	1,97
5/16"	9/16" 18h UNF	241420905	1,89
3/8"	9/16" 18h UNF	241420906	2,05
3/8"	5/8" 18h UNF	241421006	3,22
5/16"	3/4" 16h UNF	241421205	2,82
3/8"	3/4" 16h UNF	241421206	2,59
1/2"	3/4" 16h UNF	241421208	3,21
3/8"	7/8" 14h UNF	241421406	3,00
1/2"	7/8" 14h UNF	241421408	3,32
5/8"	7/8" 14h UNF	241421410	4,32
1/2"	1"1/16 12h UNF	241421708	4,95
5/8"	1"1/16 12h UNF	241421710	5,46
3/4"	1"1/16 12h UNF	241421712	4,90
1"	1"1/16 12h UNF	241421716	9,96
3/4"	1"5/16 12h UNF	241422112	11,04
1"	1"5/16 12h UNF	241422116	11,42
1"	1"5/8 12h UNF	241422616	17,80
1"1/4	1"5/8 12h UNF	241422620	16,73
1"1/4	1"7/8 12h UNF	241423020	33,56
1"1/2	1"7/8 12h UNF	241423024	24,92
2"	2"1/2 12h UNF	241424032	45,24

Hembras giratorias rectas JIC 37° doble hexagono

JIC swivel female 37° cone double hex.

Femelle JIC 37° double hexagonal

Femmina diritta JIC 37° doppio esagono

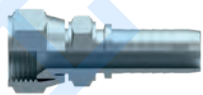

DN	ROSCA THREAD	Referencia Part n°	€
1/4"	7/16" 20h UNF	242420704	2,61
1/4"	1/2" 20h UNF	242420804	2,80
5/16"	9/16" 18h UNF	242420905	3,44
3/8"	9/16" 18h UNF	242420906	3,38
3/8"	3/4" 16h UNF	242421206	3,82
1/2"	3/4" 16h UNF	242421208	4,45
1/2"	7/8" 14h UNF	242421408	5,54
3/4"	1"1/16 12h UN	242421712	8,43
1"	1"5/16 12h UN	242422116	11,70
1"1/4	1"5/8 12h UN	242422620	24,81
1"1/2	1"7/8 12h UN	242423024	38,16
2"	2"1/2 12h UN	242424032	69,75

Hembras giratorias 90° JIC 37°

JIC Swivel female 37° cone (90° Elbow)

Coude 90° femelle tournante cône JIC 37°

Femmina a 90° JIC 37°



DN	ROSCA THREAD	Referencia Part n°	€
3/16"	7/16" 20h UNF	241380703	4,70
1/4"	7/16" 20h UNF	241380704	3,15
1/4"	1/2" 20h UNF	241380804	3,32
1/4"	9/16" 18h UNF	241380904	2,98
5/16"	9/16" 18h UNF	241380905	4,03
3/8"	9/16" 18h UNF	241380906	4,54
3/8"	5/8" 18h UNF	241381006	5,40
3/8"	3/4" 16h UNF	241381206	4,42
1/2"	3/4" 16h UNF	241381208	4,21
3/8"	7/8" 14h UNF	241381406	8,11
1/2"	7/8" 14h UNF	241381408	5,80
5/8"	7/8" 14h UNF	241381410	8,85
1/2"	1"1/16 12h UNF	241381708	12,53
5/8"	1"1/16 12h UNF	241381710	10,82
3/4"	1"1/16 12h UNF	241381712	10,10
3/4"	1"5/16 12h UNF	241382112	19,67
1"	1"5/16 12h UNF	241382116	16,75
1"	1"5/8 12h UNF	241382616	34,14
1"1/4	1"5/8 12h UNF	241382620	33,01
1"1/4	1"7/8 12h UNF	241383020	53,10
1"1/2	1"7/8 12h UNF	241383024	47,75
2"	2"1/2 12h UNF	241384032	97,93

Hembras giratorias 45° JIC 37°

JIC swivel female 37° cone (45° Elbow)

Coude 45° femelle tournante cône JIC 37°

Femmina a 45° JIC 37°



DN	ROSCA THREAD	Referencia Part n°	€
1/4"	7/16" 20h UNF	241390704	3,18
1/4"	1/2" 20h UNF	241390804	3,96
1/4"	9/16" 18h UNF	241390904	4,08
5/16"	9/16" 18h UNF	241390905	3,76
3/8"	9/16" 18h UNF	241390906	4,10
3/8"	3/4" 16h UNF	241391206	6,00
1/2"	3/4" 16h UNF	241391208	6,12
1/2"	7/8" 14h UNF	241391408	7,68
5/8"	7/8" 14h UNF	241391410	7,92
1/2"	1"1/16 12h UNF	241391708	12,12
5/8"	1"1/16 12h UNF	241391710	11,70
3/4"	1"1/16 12h UNF	241391712	10,14
3/4"	1"5/16 12h UNF	241392112	20,63
1"	1"5/16 12h UNF	241392116	17,29
1"	1"5/8 12h UNF	241392616	34,14
1"1/4	1"5/8 12h UNF	241392620	37,13
1"1/4	1"7/8 12h UNF	241393020	55,69
1"1/2	1"7/8 12h UNF	241393024	55,69
2"	2"1/2 12h UNF	241394032	101,49

CONEXIONES SERIE STANDARD

Standard series fittings

Embouts série Standard

Raccordi serie Standard

Macho JIC 37°

Male JIC 37° cone

Mâle fixe JIC cône 37°

Maschio JIC 37°



DN	ROSCA THREAD	Referencia Part n°	€
1/4"	7/16" 20h UNF	241400704	1,48
1/4"	1/2" 20h UNF	241400804	2,66
5/16"	1/2" 20h UNF	241400805	2,60
1/4"	9/16" 18h UNF	241400904	1,66
5/16"	9/16" 18h UNF	241400905	2,21
3/8"	9/16" 18h UNF	241400906	1,79
3/8"	3/4" 16h UNF	241401206	2,57
1/2"	3/4" 16h UNF	241401208	2,32
3/8"	7/8" 14h UNF	241401406	3,81
1/2"	7/8" 14h UNF	241401408	2,79
5/8"	7/8" 14h UNF	241401410	3,99
1/2"	1"1/16 12h UNF	241401708	5,74
5/8"	1"1/16 12h UNF	241401710	5,20
3/4"	1"1/16 12h UNF	241401712	6,72
3/4"	1"5/16 12h UNF	241402112	9,94
1"	1"5/16 12h UNF	241402116	12,11
1"	1"5/8 12h UNF	241402616	19,66
1"1/4	1"5/8 12h UNF	241402620	21,52
1"1/4	1"7/8 12h UNF	241403020	29,85
1"1/2	1"7/8 12h UNF	241403024	29,85
2"	2"1/2 12h UNF	241404032	55,27

Espigas de prensar dobles

Double hose tail for crimping

Embout double jonction

Giunzione tubo-tubo



DN	Referencia Part n°	€
1/4"	243000404	2,18
5/16"	243000505	2,68
5/16" -- 3/8"	NEW 243000506	2,50
3/8"	243000606	2,51
1/2"	243000808	3,02
3/4"	243001212	9,92
1"	243001616	16,02

Machos Stecko

Stecko male connections

Mâle fixe Stecko

Maschio Stecko



DN	STECKO	Referencia Part n°	€
1/4"	1/4"	241900404	2,66
3/8"	3/8"	241900606	4,20
1/2"	1/2"	241900808	8,09
3/4"	3/4"	241901212	8,57

CONEXIONES SERIE STANDARD

Standard series fittings
Emboutis série Standard
Raccordi serie Standard

Hembras giratorias Métricas cono 24° con junta tórica

Metric swivel female 24° cone with o'ring

Femelle tournante droite Métrique cône 24° + o'ring

Femmina Metrica sede 24° con o'ring

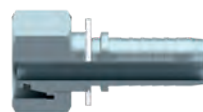

DN	TUBO PIPE	ROSCA THREAD	SERIE SERIES	Referencia Part n°	€
3/16"	6	12X1,5	L	24804120603	2,02
1/4"	6	12X1,5	L	24804120604	1,83
1/4"	8	14X1,5	L	24804140804	1,67
5/16"	8	14x1.5	L	24804140805	2,12
3/8"	8	14x1.5	L	24804140806	2,38
1/4"	10	16X1,5	L	24804161004	2,05
5/16"	10	16X1,5	L	24804161005	2,11
3/8"	10	16X1,5	L	24804161006	2,34
1/4"	12	18X1,5	L	24804181204	2,45
5/16"	12	18X1,5	L	24804181205	2,33
3/8"	12	18X1,5	L	24804181206	2,20
1/2"	12	18x1.5	L	24804181208	3,10
1/4"	15	22x1.5	L	24804221504	3,72
5/16"	15	22x1.5	L	24804221505	3,72
3/8"	15	22X1,5	L	24804221506	3,63
1/2"	15	22X1,5	L	24804221508	2,97
3/8"	18	26x1.5	L	24804261806	4,99
1/2"	18	26X1,5	L	24804261808	4,78
5/8"	18	26X1,5	L	24804261810	3,87
3/4"	18	26x1.5	L	24804261812	5,10
1/2"	22	30x2	L	24804302208	6,29
5/8"	22	30x2	L	24804302210	9,10
3/4"	22	30X2	L	24804302212	6,06
3/4"	28	36x2	L	24804362812	8,45
1"	28	36X2	L	24804362816	11,85
1"	35	45x2	L	24804453516	14,66
1"1/4	35	45X2	L	24804453520	17,29
1"1/4	42	52X2	L	24804524220	22,87
1"1/2	42	52X2	L	24804524224	25,14
2"	42	52x2	L	24804524232	27,09
1/4"	6	14x1.5	S	24804140604	2,04
3/16"	8	16X1,5	S	24804160803	2,75
1/4"	8	16X1,5	S	24804160804	2,35
5/16"	8	16x1.5	S	24804160805	2,38
3/8"	8	16x1.5	S	24804160806	2,57
1/4"	10	18X1,5	S	24804181004	2,60
5/16"	10	18x1.5	S	24804181005	2,56
3/8"	10	18X1,5	S	24804181006	2,94
1/4"	12	20x1,5	S	24804201204	2,94
5/16"	12	20X1,5	S	24804201205	2,33
3/8"	12	20X1,5	S	24804201206	2,38
1/2"	12	20X1,5	S	24804201208	3,46
5/16"	14	22x1.5	S	24804221405	3,70
3/8"	14	22X1,5	S	24804221406	3,43
1/2"	14	22x1.5	S	24804221408	3,21
1/4"	16	24x1.5	S	24804241604	3,70
5/16"	16	24x1.5	S	24804241605	4,43
3/8"	16	24x1.5	S	24804241606	3,93
1/2"	16	24X1,5	S	24804241608	3,97
5/8"	16	24x1.5	S	24804241610	4,04
3/8"	20	30x2	S	24804302006	6,33
1/2"	20	30x2	S	24804302008	5,23
5/8"	20	30X2	S	24804302010	4,99
3/4"	20	30X2	S	24804302012	6,64
1/2"	25	36x2	S	24804362508	11,50
5/8"	25	36x2	S	24804362510	9,13
3/4"	25	36X2	S	24804362512	11,13
1"	25	36X2	S	24804362516	13,82
5/8"	30	42x2	S	24804423010	10,46
3/4"	30	42x2	S	24804423012	10,69
1"	30	42X2	S	24804423016	16,29
1"1/4	38	52x2	S	24804523820	23,61

Hembras giratorias 90° Métricas cono 24° con junta tórica

Metric swivel female 24° cone with o'ring
(90° Elbow)

Coude 90° femelle tournante Métrique cône 24° + o'ring

Femmina Metrica a 90° sede 24° con o'ring



DN	TUBO PIPE	SERIE SERIES	ROSCA THREAD	Referencia Part n°	€
3/16"	6	L	12x1,5	24305120603	2,71
1/4"	6	L	12x1,5	24305120604	3,05
1/4"	8	L	14x1,5	24305140804	3,15
5/16"	8	L	14x1,5	24305140805	3,77
1/4"	10	L	16x1,5	24305161004	3,32
5/16"	10	L	16x1,5	24305161005	3,42
3/8"	10	L	16x1,5	24305161006	3,68
1/4"	12	L	18x1,5	24305181204	5,56
5/16"	12	L	18x1,5	24305181205	4,13
3/8"	12	L	18x1,5	24305181206	3,65
1/2"	12	L	18x1,5	24305181208	5,24
3/8"	15	L	22x1,5	24305221506	6,00
1/2"	15	L	22x1,5	24305221508	5,04
1/2"	18	L	26x1,5	24305261808	7,87
5/8"	18	L	26x1,5	24305261810	8,42
5/8"	22	L	30x2	24305302210	13,78
3/4"	22	L	30x2	24305302212	11,17
3/4"	28	L	36x2	24305362812	11,93
1"	28	L	36x2	24305362816	19,11
1"1/4	35	L	45x2	24305453520	32,62
1"1/2	42	L	52x2	24305524224	56,93
3/16"	6	S	14x1,5	24305140603	3,49
1/4"	8	S	16x1,5	24305160804	3,23
5/16"	8	S	16x1,5	24305160805	3,77
1/4"	10	S	18x1,5	24305181004	3,30
5/16"	10	S	18x1,5	24305181005	4,54
3/8"	10	S	18x1,5	24305181006	5,68
1/4"	12	S	20x1,5	24305201204	5,18
5/16"	12	S	20x1,5	24305201205	4,48
3/8"	12	S	20x1,5	24305201206	3,41
1/2"	12	S	20x1,5	24305201208	4,84
3/8"	14	S	22x1,5	24305221406	5,36
3/8"	16	S	24x1,5	24305241606	4,94
1/2"	16	S	24x1,5	24305241608	5,54
5/8"	20	S	30x2	24305302010	9,87
3/4"	20	S	30x2	24305302012	12,95
3/4"	25	S	36x2	24305362512	16,50
1"	25	S	36x2	24305362516	21,44
5/8"	30	S	42x2	24305423010	12,43
3/4"	30	S	42x2	24305423012	13,05
1"	30	S	42x2	24305423016	25,58
1"1/4	38	S	52x2	24305523820	45,02

CONEXIONES SERIE STANDARD

Standard series fittings

Embouts série Standard

Raccordi serie Standard

Hembras giratorias 45° Métricas cono 24° con junta tórica

Metric swivel female 24° cone with o'ring (45° Elbow)

Coude 45° femelle tournante Métrique cône 24°+ o'ring

Femmina Metrica a 45° sede 24° con o'ring



Machos fijos Métricos cono 24°

Male stud Metric thread 24° cone

Mâle fixe Métrique cône 24°

Maschio Metrico sede 24°



DN	TUBO PIPE	SERIE SERIES	ROSCA THREAD	Referencia Part n°	€
3/16"	6	L	12x1,5	24306120603	3,74
1/4"	6	L	12x1,5	24306120604	3,08
1/4"	8	L	14x1,5	24306140804	3,18
5/16"	8	L	14x1,5	24306140805	3,87
1/4"	10	L	16x1,5	24306161004	3,49
5/16"	10	L	16x1,5	24306161005	3,43
3/8"	10	L	16x1,5	24306161006	3,74
1/4"	12	L	18x1,5	24306181204	4,34
5/16"	12	L	18x1,5	24306181205	4,58
3/8"	12	L	18x1,5	24306181206	3,32
1/2"	12	L	18x1,5	24306181208	5,38
3/8"	15	L	22x1,5	24306221506	6,23
1/2"	15	L	22x1,5	24306221508	5,95
1/2"	18	L	26x1,5	24306261808	8,07
5/8"	18	L	26x1,5	24306261810	8,76
5/8"	22	L	30x2	24306302210	9,56
3/4"	22	L	30x2	24306302212	12,66
3/4"	28	L	36x2	24306362812	12,24
1"	28	L	36x2	24306362816	19,87
1"1/4	35	L	45x2	24306453520	34,57
1"1/2	42	L	52x2	24306524224	53,18
3/16"	6	S	14x1,5	24306140603	4,48
1/4"	6	S	14x1,5	24306140604	3,82
1/4"	8	S	16x1,5	24306160804	4,11
5/16"	8	S	16x1,5	24306160805	3,87
1/4"	10	S	18x1,5	24306181004	4,88
5/16"	10	S	18x1,5	24306181005	4,07
3/8"	10	S	18x1,5	24306181006	4,07
1/4"	12	S	20x1,5	24306201204	4,71
5/16"	12	S	20x1,5	24306201205	5,52
3/8"	12	S	20x1,5	24306201206	5,39
1/2"	12	S	20x1,5	24306201208	5,31
3/8"	14	S	22x1,5	24306221406	6,33
3/8"	16	S	24x1,5	24306241606	5,58
1/2"	16	S	24x1,5	24306241608	6,22
5/8"	20	S	30x2	24306302010	11,12
3/4"	20	S	30x2	24306302012	12,89
3/4"	25	S	36x2	24306362512	16,31
1"	25	S	36x2	24306362516	20,22
3/4"	30	S	42x2	24306423012	13,38
1"	30	S	42x2	24306423016	25,04
1"1/4	38	S	52x2	24306523820	47,00

DN	TUBO PIPE	SERIE SERIES	ROSCA THREAD	Referencia Part n°	€
3/16"	6	L	12x1,5	24203120603	1,61
1/4"	6	L	12x1,5	24203120604	1,81
1/4"	8	L	14x1,5	24203140804	1,85
1/4"	10	L	16x1,5	24203161004	2,41
5/16"	10	L	16x1,5	24203161005	1,86
3/8"	10	L	16x1,5	24203161006	1,96
1/4"	12	L	18x1,5	24203181204	2,19
5/16"	12	L	18x1,5	24203181205	2,48
3/8"	12	L	18x1,5	24203181206	1,80
3/8"	15	L	22x1,5	24203221506	3,27
1/2"	15	L	22x1,5	24203221508	3,13
1/2"	18	L	26x1,5	24203261808	4,15
5/8"	18	L	26x1,5	24203261810	3,42
3/4"	22	L	30x2	24203302212	5,68
1"	28	L	36x2	24203362816	11,76
1"1/4	35	L	45x2	24203453520	18,05
1"1/2	42	L	52x2	24203524224	27,04
1/4"	8	S	16x1,5	24203160804	2,17
1/4"	10	S	18x1,5	24203181004	2,75
5/16"	10	S	18x1,5	24203181005	2,57
3/8"	10	S	18x1,5	24203181006	2,71
5/16"	12	S	20x1,5	24203201205	2,68
3/8"	12	S	20x1,5	24203201206	2,77
3/8"	14	S	22x1,5	24203221406	3,30
1/2"	16	S	24x1,5	24203241608	3,74
5/8"	20	S	30x2	24203302010	5,70
3/4"	20	S	30x2	24203302012	6,62
3/4"	25	S	36x2	24203362512	11,15
1"	25	S	36x2	24203362516	12,00
1"	30	S	42x2	24203423016	16,91
1"1/4	38	S	52x2	24203523820	25,46

CONEXIONES SERIE STANDARD

Standard series fittings
Embouts série Standard
Raccordi serie Standard

Orientable Métrico Recto

Banjo metric

Banjo droit Métrique

Raccordo ad occhio Metrico



DN	Ø	Referencia Part n°	€
3/16"	M10x1	241161003	2,73
1/4"	M10x1	241161004	2,72
5/16"	M10x1	241161005	2,91
1/8"	M12x1	241161202*	11,96
3/16"	M12x1.5	241161203	2,56
1/4"	M12x1.5	241161204	2,81
1/4"	M14x1.5	241161404	3,26
5/16"	M14x1.5	241161405	3,74
3/8"	M14x1.5	241161406	3,42
5/16"	M16x1.5	241161605	3,47
3/8"	M16x1.5	241161606	3,32
3/8"	M18x1.5	241161806	4,47
1/2"	M18x1.5	241161808	4,47
1/2"	M22x1.5	241162208	6,86
5/8"	M22x1.5	241162210	5,92
3/4"	M30x2	241163012	11,36

Hasta fin de existencias / Until end of stock / Jusqu'à la fin du stock / Fino ad esaurimento

*Hasta fin de existencias. / *Until end of stock. / *Jusqu'à la fin du stock. / *Fino ad esaurimento scorta.

Tornillo orientable simple rosca Métrica

Metric bolt for Banjo

Vis creuse simple pour banjo filetage métrique

Bullone forato Metrico

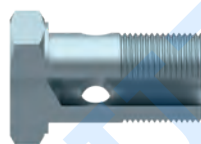

ROSCA THREAD	Referencia Part n°	€
M8x1	S109208	1,07
M10x1	S109210	1,07
M12x1.5	S109212	1,22
M14x1.5	S109214	1,27
M16x1.5	S109216	1,56
M18x1.5	S109218	2,10
M22x1.5	S109222	2,91
M26x1.5	S109226	4,79
M30x1.5	S109230	10,34

*Ver precios en p302 (ADAPTADORES BSP) / *See prices in p.302 (BSP ADAPTORS) / *Prix à la p.302 (ADAPTEURS BSP) / *Vedere prezzi p.302 (ADATTATORI BSP)

Espiga lisa recta Métrica

Metric standpipe

Embout lisse droit Métrique

Estremità tubolare diritta Metrica



DN	TUBO PIPE	Referencia Part n°	€
1/8"	6	241580602 L	2,37
3/16"	6	241580603 L	1,14
1/4"	6	241580604 L	1,57
3/16"	8	241580803 L	1,56
1/4"	8	241580804 L	1,24
5/16"	8	241580805 L	4,40
5/16"	10	241581005 L	1,90
3/8"	10	241581006 L	1,52
3/8"	12	241581206 L	1,61
1/2"	12	241581208 L	6,02
3/8"	15	241581506 L	2,13
1/2"	15	241581508 L	2,30
1/2"	18	241581808 L	2,31
5/8"	18	241581810 L	4,00
3/4"	22	241582212 L	4,81
1"	28	241582816 L	8,50
1"1/4	35	241583520 L	16,23
1"1/2	42	241584224 L	16,85
1/4"	10	241581004 S	1,22
1/4"	12	241581204 S	2,09
5/16"	12	241581205 S	1,89
3/8"	14	241581406 S	2,59
1/2"	14	241581408 S	3,26
1/2"	16	241581608 S	3,05
3/4"	20	241582012 S	5,48
1"	25	241582516 S	10,25
1"	30	241583016 S	9,49

CONEXIONES SERIE STANDARD

Standard series fittings
Embouts série Standard
Raccordi serie Standard

Hembras giratorias Métricas cono 24° /60°

Female metric swivel 24° /60° cone

Femelle tournante Métrique cône 24° -60°

Femmina Metrica Girevole Multiseal 24° /60°

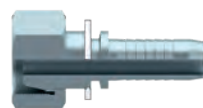

DN	TUBO PIPE	ROSCA THREAD	Referencia Part n°	€
1/4"	8L	M14X1.5	244049511	1,99
1/4"	10L	M16X1.5	244049520	2,40
5/16"	10L	M16X1.5	244049523	2,34
3/8"	10L	M16X1.5	244049524	2,88
5/16"	12L	M18X1.5	244049525	2,74
3/8"	12L	M18X1.5	244049535	2,75
3/8"	15L	M22X1.5	244049552	4,35
1/2"	15L	M22X1.5	244049555	4,56
5/8"	18L	M26X1.5	244049571	5,96

Hembras giratorias 90° Métricas cono 24° /60°

Female metric swivel 24° /60° cone (90° Elbow)

Femelle tournante coude 90° Métrique cône 24° -60°

Femmina Metrica Girevole a 90° Multiseal 24° /60°



DN	TUBO PIPE	ROSCA THREAD	Referencia Part n°	€
1/4"	8L	M14X1.5	244059511	2,52
1/4"	10L	M16X1.5	244059520	2,91
5/16"	10L	M16X1.5	244059523	2,73
3/8"	10L	M16X1.5	244059524	3,64
5/16"	12L	M18X1.5	244059525	3,17
3/8"	12L	M18X1.5	244059535	3,17
3/8"	15L	M22X1.5	244059552	5,36
1/2"	15L	M22X1.5	244059555	5,72
5/8"	18L	M26X1.5	244059571	8,24

Hembras giratorias 45° Métricas cono 24° /60°

Female metric swivel 24° /60° cone (45° Elbow)

Femelle tournante coude 45° Métrique cône 24° -60°

Femmina Metrica Girevole a 45° Multiseal 24° /60°



DN	TUBO PIPE	ROSCA THREAD	Referencia Part n°	€
1/4"	8L	M14X1.5	244069511	3,90
5/16"	10L	M16X1.5	244069523	4,15
3/8"	10L	M16X1.5	244069524	4,88
5/16"	12L	M18X1.5	244069525	4,88
3/8"	12L	M18X1.5	244069535	3,39
1/2"	15L	M22X1.5	244069555	7,00
5/8"	18L	M26X1.5	244069571	10,40

ROSCA MÉTRICA - ESTANQUEIDAD CONO METAL-METAL

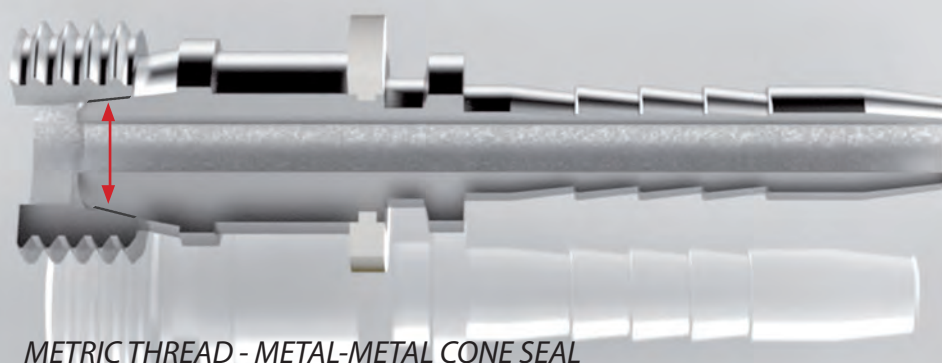

CONEXIONES SERIE STANDARD

Standard series fittings
Embouts série Standard
Raccordi serie Standard

Macho rosca cónica NPT

NPT male thread

Mâle fixe gaz conique NPT

Maschio NPT 60



DN	ROSCA THREAD	Referencia Part n°	€
3/16"	1/8" NPT	241610203	1,58
1/4"	1/8" NPT	241610204	1,97
3/16"	1/4" NPT	241610403	2,15
1/4"	1/4" NPT	241610404	2,11
5/16"	1/4" NPT	241610405	2,93
3/8"	1/4" NPT	241610406	2,93
1/4"	3/8" NPT	241610604	2,82
5/16"	3/8" NPT	241610605	2,98
3/8"	3/8" NPT	241610606	2,61
1/2"	3/8" NPT	241610608	3,55
3/8"	1/2" NPT	241610806	3,43
1/2"	1/2" NPT	241610808	2,67
5/8"	1/2" NPT	241610810	5,07
1/2"	3/4" NPT	241611208	6,72
5/8"	3/4" NPT	241611210	5,65
3/4"	3/4" NPT	241611212	5,64
1"	3/4" NPT	241611216	9,72
3/4"	1" NPT	241611612	10,06
1"	1" NPT	241611616	9,89
1"	1"1/4 NPT	241612016	20,01
1"1/4"	1"1/4 NPT	241612020	19,93
1"1/4"	1"1/2 NPT	241612420	26,59
1"1/2"	1"1/2 NPT	241612424	26,59
1"1/2"	2" NPT	241613224	55,55
2"	2" NPT	241613232	46,63

Hembras giratorias NPSM

NPSM swivel female

Femelle tournante NPSM

Femmina diritta NPSM

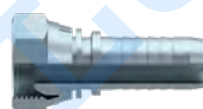

DN	ROSCA THREAD	Referencia Part n°	€
1/4"	1/4" NPSM	242610404	2,44
3/8"	3/8" NPSM	242610606	2,97
1/2"	1/2" NPSM	242610808	3,92
3/4"	3/4" NPSM	242611212	6,16
1"	1" NPSM	242611616	10,12

Hembras giratorias rectas Komatsu cono 60°

Komatsu swivel female 60° cone

Femelle tournante droite Komatsu Métrique (cône 60°)

Femmina Komatsu sede 60°



DN	ROSCA THREAD	Referencia Part n°	€
1/4"	M14X1.5	258049625	4,64
3/8"	M18X1.5	258049635	4,19
1/2"	M22X1.5	258049655	7,83
5/8"	M24X1.5	258049665	9,80
3/4"	M30X1.5	258049684	11,54
1"	M33X1.5	258049685	16,50
1" 1/4	M36X1.5	NEW 258049695	30,60
1" 1/2	M42X1.5	NEW 258049697	47,16

Hembras giratorias rectas TOYOTA

TOYOTA swivel female

Femelle tournante TOYOTA

Femmina diritta TOYOTA



DN	ROSCA THREAD	Referencia Part n°	€
1/4"	1/4" BSP	251000404	3,77
3/8"	3/8" BSP	251000606	4,82
1/2"	1/2" BSP	251000808	6,47
3/4"	3/4" BSP	251001212	9,83
1"	1" BSP	251001616	17,70

CONEXIONES SERIE STANDARD

Standard series fittings
Embouts série Standard
Raccordi serie Standard

Macho Métrico cono 24° serie francesa

Metric stud 24° cone French Series

Mâle fixe Série Française Métrique 24°

Maschio Metrico sede 24° serie francese



DN	TUBO PIPE	ROSCA THREAD	Referencia Part n°	€
1/4"	13.2	M20X1.5	245032013204	2,61
5/16"	13.2	M20X1.5	245032013205	2,51
3/8"	13.2	M20X1.5	245032013206	2,44
5/16"	16.7	M24X1.5	245032416705	3,91
3/8"	16.7	M24X1.5	245032416706	3,91
1/2"	16.7	M24X1.5	245032416708	3,92
5/8"	21.2	M30X1,5	245033021210	7,01
3/4"	21.2	M30X1,5	245033021212	6,52
3/4"	26.7	M36X1.5	245033626712	10,44
1"	33.5	M45X1.5	245034533516	16,96

Macho Métrico válvula agrícola

Metric stud for agricultural valve

Mâle fixe Métrique pour valve agricole

Maschio Metrico per valvola agricola



DN	ROSCA THREAD	Referencia Part n°	€
1/4"	M18X1.5	245051804	3,52
5/16"	M18X1.5	245051805	3,29
3/8"	M18X1.5	245051806	3,29

Hembra giratoria recta Métrica cono 24° serie francesa

Metric swivel female 24° cone French Series

Femelle tournante Série Française Métrique 24°

Femmina Metrica sede 24° serie francese



DN	TUBO PIPE	ROSCA THREAD	Referencia Part n°	€
1/4"	13.2	M20X1.5	245042013204	2,90
5/16"	13.2	M20X1.5	245042013205	3,14
3/8"	13.2	M20X1.5	245042013206	3,08
5/16"	16.7	M24X1.5	245042416705	4,48
3/8"	16.7	M24X1.5	245042416706	4,78
1/2"	16.7	M24X1.5	245042416708	4,78
5/8"	21.2	M30X1.5	245043021210	7,31
3/4"	26.7	M36X1.5	245043626712	11,30
1"	33.5	M45X1.5	245044533516	19,14

Hembra giratoria 90° Métrica cono 24° serie francesa

Metric swivel female 24° cone French Series (90° Elbow)

Femelle tournante coude 90° Série Française Métrique 24°

Femmina Metrica a 90° sede 24° serie francese



DN	TUBO PIPE	ROSCA THREAD	Referencia Part n°	€
5/16"	13.2	M20X1.5	245052013205	5,70
3/8"	13.2	M20X1.5	245052013206	6,19
1/2"	16.7	M24X1.5	245052416708	7,86
5/8"	21.2	M30X1.5	245053021210	15,51
3/4"	26.7	M36X1.5	245053626712	23,21

CONEXIONES SERIE STANDARD

Standard series fittings
Embouts série Standard
Raccordi serie Standard

Hembra giratoria recta ORFS asiento plano

ORFS Swivel female straight flat seat

Femelle tournante -ORFS fond plat

Femmina diritta sede piana ORFS



DN	ROSCA THREAD	Referencia Part n°	€
1/4"	9/16" 18h UNF	449000404	2,36
1/4"	11/16" 16h UNF	449000604	2,36
5/16"	11/16" 16h UNF	449000605	3,13
3/8"	11/16" 16h UNF	449000606	2,96
3/8"	13/16" 16h UNF	449000806	2,79
1/2"	13/16" 16h UNF	449000808	3,33
1/2"	1" 14h UNF	449001008	5,79
5/8"	1" 14h UNF	449001010	6,68
1/2"	1" 3/16 12h UNF	449001208	8,96
3/4"	1" 3/16 12h UNF	449001212	8,48
3/4"	1" 7/16 12h UNF	449001612	12,97
1"	1" 7/16 12h UNF	449001616	9,56
1"1/4	1"11/16 12h UNF	449002020	24,29
1"1/2	2" 12h UNF	449002424	41,62

Hembra giratoria 90º ORFS asiento plano

ORFS Swivel female flat seat (90° Elbow)

Femelle tournante coude 90° -ORFS fond plat

Femmina a 90° sede piana ORFS



DN	ROSCA THREAD	Referencia Part n°	€
1/4"	9/16" 18h UNF	449070404	3,62
1/4"	11/16" 16h UNF	449070604	5,18
5/16"	11/16" 16h UNF	449070605	5,18
3/8"	11/16" 16h UNF	449070606	4,64
3/8"	13/16" 16h UNF	449070806	6,97
1/2"	13/16" 16h UNF	449070808	5,86
1/2"	1" 14h UNF	449071008	9,67
5/8"	1" 14h UNF	449071010	9,73
1/2"	1" 3/16-12h UNF	449071208	15,19
3/4"	1" 3/16 12h UNF	449071212	13,67
3/4"	1" 7/16 12h UNF	449071612	23,07
1"	1" 7/16 12h UNF	449071616	23,91
1"1/4	1"11/16 12h UNF	449072020	41,82
1"1/2	2" 12h UNF	449072424	60,57

Machos ORFS asiento plano con junta tórica

ORFS Male flat seat + o'ring

Mâle fixe -ORFS fond plat + o'ring

Maschio ORFS sede piana con o'ring



DN	ROSCA THREAD	Referencia Part n°	€
1/4"	9/16" 18h UNF	449120404	2,18
1/4"	11/16" 16h UNF	449120604	3,06
5/16"	11/16" 16h UNF	449120605	2,78
3/8"	11/16" 16h UNF	449120606	3,10
3/8"	13/16" 16h UNF	449120806	4,13
1/2"	13/16" 16h UNF	449120808	4,13
1/2"	1" 14h UNF	449121008	5,06
5/8"	1" 14h UNF	449121010	5,36
1/2"	1" 3/16 12h UNF	449121208	8,71
3/4"	1" 3/16 12h UNF	449121212	7,36
3/4"	1" 7/16 12h UNF	449121612	14,41
1"	1" 7/16 12h UNF	449121616	14,41
1"1/4	1"11/16-12h UNF	449122020	24,29

Hembra giratoria 45º ORFS asiento plano

ORFS Swivel female (45° Elbow) flat seat

Femelle tournante coude 45° -ORFS fond plat

Femmina a 45° sede piana ORFS



DN	ROSCA THREAD	Referencia Part n°	€
1/4"	9/16" 18h UNF	449080404	3,48
1/4"	11/16" 16h UNF	449080604	4,71
5/16"	11/16" 16h UNF	449080605	4,71
3/8"	11/16" 16h UNF	449080606	4,99
3/8"	13/16" 16h UNF	449080806	6,40
1/2"	13/16" 16h UNF	449080808	6,40
1/2"	1" 14h UNF	449081008	10,60
5/8"	1" 14h UNF	449081010	10,65
1/2"	1" 3/16 12h UNF	449081208	15,19
3/4"	1" 3/16 12h UNF	449081212	15,96
3/4"	1" 7/16 12h UNF	449081612	23,91
1"	1" 7/16 12h UNF	449081616	27,57
1"1/4	1"11/16 12h UNF	449082020	39,26
1"1/2	2" 12h UNF	449082424	60,57

Juntas tóricas para ORFS

O'rings for ORFS

O'rings pour ORFS

O'rings per raccordi ORFS



Ø INT. Ø INNER	Espesor (mm) Thickness (mm)	Referencia Part n°	€
7,65	1,78	7.65X1.78	0,08
9,25	1,78	9.25X1.78	0,10
12,42	1,78	12.42X1.78	0,11
15,60	1,78	15.60X1.78	0,14
18,77	1,78	18.77X1.78	0,17
23,52	1,78	23.52X1.78	0,22
29,87	1,78	29.87X1.78	0,28
37,82	1,78	37.82X1.78	0,37

CONEXIONES SERIE STANDARD

Standard series fittings
Embouts série Standard
Raccordi serie Standard

Brida recta SAE 3000 PSI

3000 PSI SAE Straight Flange / Code 61

Bride SAE droite série 3000 PSI

Flangia diritta SAE 3000 PSI



DN	∅	Referencia Part n°	€
1/2"	30.2	241820808	7,93
1/2"	38.1	241821208	11,90
5/8"	38.1	241821210	13,48
3/4"	38.1	241821212	11,76
3/4"	44.5	241821612	21,36
1"	44.5	241821616	19,16
1"	50.8	241822016	27,38
1 1/4"	50.8	241822020	23,53
1 1/4"	60.3	241822420	41,06
1 1/2"	60.3	241822424	41,06
1 1/2"	71.4	241823224	82,10
2"	71.4	241823232	63,16
2 1/2"	84.1	NEW 241824040	149,87
3"	101.6	NEW 241824848	231,51

Brida a 90° SAE 3000 PSI

3000 PSI SAE Flange (90° Elbow) / Code 61

Bride SAE coude 90° série 3000 PSI

Flangia a 90° SAE 3000 PSI



DN	∅	Referencia Part n°	€
1/2"	30.2	241830808	11,06
1/2"	38.1	241831208	14,83
5/8"	38.1	241831210	15,20
3/4"	38.1	241831212	14,87
3/4"	44.5	241831612	22,28
1"	44.5	241831616	22,86
1"	50.8	241832016	32,80
1 1/4"	50.8	241832020	34,26
1 1/4"	60.3	241832420	49,28
1 1/2"	60.3	241832424	49,99
1 1/2"	71.4	241833224	88,70
2"	71.4	241833232	92,99

Brida a 45° SAE 3000 PSI

3000 PSI SAE Flange (45° Elbow) / Code 61

Bride SAE coude 45° série 3000 PSI

Flangia a 45° SAE 3000 PSI



DN	∅	Referencia Part n°	€
1/2"	30.2	241840808	9,73
1/2"	38.1	241841208	14,83
5/8"	38.1	241841210	15,20
3/4"	38.1	241841212	14,87
3/4"	44.5	241841612	22,67
1"	44.5	241841616	23,27
1"	50.8	241842016	33,37
1 1/4"	50.8	241842020	34,26
1 1/4"	60.3	241842420	49,28
1 1/2"	60.3	241842424	49,99
1 1/2"	71.4	241843224	95,58
2"	71.4	241843232	92,99

Brida recta SAE 6000 PSI

6000 PSI SAE Straight Flange / Code 62

Bride SAE droite série 6000 PSI

Flangia diritta SAE 6000 PSI



DN	∅	Referencia Part n°	€
1/2"	31.8	242820808	9,82
1/2"	41.3	242821208	13,48
5/8"	41.3	242821210	14,04
3/4"	41.3	242821212	14,74
3/4"	47.6	242821612	20,76
1"	47.6	242821616	22,53
1"	54	242822016	28,27
1 1/4"	54	242822020	33,81
1 1/4"	63.5	242822420	46,54
1 1/2"	63.5	242822424	49,27
1 1/2"	79.4	242823224	89,27
2"	79.4	242823232	74,83

Brida a 90° SAE 6000 PSI

6000 PSI SAE Flange (90° Elbow) / Code 62

Bride SAE coude 90° série 6000 PSI

Flangia a 90° SAE 6000 PSI



DN	∅	Referencia Part n°	€
1/2"	31.8	242830808	11,07
1/2"	41.3	242831208	16,95
5/8"	41.3	242831210	16,38
3/4"	41.3	242831212	15,46
3/4"	47.6	242831612	24,21
1"	47.6	242831616	24,79
1"	54	242832016	35,35
1 1/4"	54	242832020	36,44
1 1/4"	63.5	242832420	52,83
1 1/2"	63.5	242832424	53,86
1 1/2"	79.4	242833224	94,62

Brida a 45° SAE 6000 PSI

6000 PSI SAE Flange (45° Elbow) / Code 62

Bride SAE coude 45° série 6000 PSI

Flangia a 45° SAE 6000 PSI



DN	∅	Referencia Part n°	€
1/2"	31.8	242840808	11,93
1/2"	41.3	242841208	16,95
5/8"	41.3	242841210	16,38
3/4"	41.3	242841212	15,46
3/4"	47.6	242841612	24,64
1"	47.6	242841616	24,79
1"	54	242842016	35,35
1 1/4"	54	242842020	36,44
1 1/4"	63.5	242842420	52,83
1 1/2"	63.5	242842424	54,81
1 1/2"	79.4	242843224	94,62
2"	79.4	242843232	96,59

CONEXIONES SERIE STANDARD

Standard series fittings
Embouts série Standard
Raccordi serie Standard

Brida recta 9000 PSI (14,3)

9000 PSI straight Flange (14,3)

Bride tournante droite série 9000 PSI (14,3)

Flangia diritta PSI 9000 (14,3)



DN	∅	Referencia Part n°	€
1/2"	41,3	442821212	16,44
3/4"	47,6	442821612	26,62
1"	47,6	442821616	25,25
1"	54	442822016	33,28
1" 1/4	54	442822020	32,70
1" 1/2	63,5	442822424	58,00

Brida a 90° 9000 PSI (14,3)

9000 PSI 90° Flange (14,3)

Bride tournante coude 90° série 9000 PSI (14,3)

Flangia a 90° PSI 9000 (14,3)



DN	∅	Referencia Part n°	€
3/4"	41,3	442831212	20,82
3/4"	47,6	442831612	33,28
1"	47,6	442831616	33,28
1"	54	442832016	46,18
1" 1/4	54	442832020	46,18
1" 1/2	63,5	442832424	58,00

Brida a 45° 9000 PSI (14,3)

9000 PSI 45° Flange (14,3)

Bride tournante coude 45° série 9000 PSI (14,3)

Flangia a 45° PSI 9000 (14,3)



DN	∅	Referencia Part n°	€
3/4"	41,3	442841212	21,19
3/4"	47,6	442841612	33,28
1"	47,6	442841616	33,28
1"	54	442842016	46,18
1" 1/4	54	442842020	46,18
1" 1/2	63,5	442842424	58,00

FLUIDAL

CONEXIONES SERIE STANDARD

Standard series fittings
Embouts série Standard
Raccordi serie Standard

Bridas SAE partidas (semibridas) 3000/6000 PSI

3000/6000 PSI SAE Split flanges

Demi-bridés rectangulaires de fixation SAE
3000/6000 PSI

Semiflangia SAE 3000/6000 PSI



SERIE SERIES	TAMAÑO SIZE	Referencia Part n°	€
3000 PSI	1/2"	BBP308	5,61
3000 PSI	3/4"	BBP312	6,36
3000 PSI	1"	BBP316	6,97
3000 PSI	1"1/4	BBP320	8,07
3000 PSI	1"1/2	BBP324	10,20
3000 PSI	2"	BBP332	13,26
3000 PSI	2"1/2	BBP340	27,19
3000 PSI	3"	BBP348	51,35
3000 PSI	3"1/2	BBP356	58,71
3000 PSI	4"	BBP364	64,32
6000 PSI	1/2"	BBP608	6,08
6000 PSI	3/4"	BBP612	8,76
6000 PSI	1"	BBP616	13,60
6000 PSI	1"1/4	BBP620	19,15
6000 PSI	1"1/2	BBP624	28,48
6000 PSI	2"	BBP632	43,57

€/par / €/pair / €/paire / €/coppia

Bridas SAE enteras (monoblock) 3000/6000 PSI

3000/6000 PSI SAE Flanges

Bridés monobloc rectangulaires de fixation SAE
3000/6000 PSI

Flangia monoblocco SAE 3000/6000 PSI



SERIE SERIES	TAMAÑO SIZE	Referencia Part n°	€
3000 PSI	1/2"	BBE308	5,61
3000 PSI	3/4"	BBE312	8,51
3000 PSI	1"	BBE316	7,22
3000 PSI	1"1/4	BBE320	8,88
3000 PSI	1"1/2	BBE324	10,57
3000 PSI	2"	BBE332	13,74
3000 PSI	2"1/2	BBE340	28,86
3000 PSI	3"	BBE348	42,91
3000 PSI	3"1/2	BBE356	58,71
3000 PSI	4"	BBE364	81,00
3000 PSI	5"	BBE380	102,70
6000 PSI	1/2"	BBE608	6,96
6000 PSI	3/4"	BBE612	10,28
6000 PSI	1"	BBE616	13,39
6000 PSI	1"1/4	BBE620	19,85
6000 PSI	1"1/2	BBE624	29,43
6000 PSI	2"	BBE632	43,57

Tornillos para bridas SAE

Screws for SAE flanges

Vis pour brides SAE

Vite per flangia SAE



ROSCA THREAD	TAMAÑO SIZE	Referencia Part n°	€
M8X30	3000-6000 PSI 1/2"	TB8X30	0,29
M10X35	3000 PSI 3/4"-1"	TB10X35	0,64
M10X40	3000 PSI 1" 1/4 - 6000 PSI 3/4"	TB10X40	0,85
M12X45	3000 PSI 1"1/2-2"-2"1/2-6000 PSI 1"	TB12X45	1,23
M14X45	6000 PSI 1"1/4	TB14X45	1,58
M16X50	3000 PSI 3"-3" 1/2-4"- 6000 PSI 1" 1/2	TB16X50	2,01
M20X70	6000 PSI 2"	TB20X70	3,90

*Ver precios en p.262 / *See prices in p.262 / *Prix à la p.262 / *Vedere prezzi p.262

Juntas tóricas para bridas SAE 3000/6000 PSI

O'rings for 3000/6000 PSI SAE flanges

O'rings pour bride série 3000/6000 PSI

O'rings per flangia SAE 3000/6000 PSI



TAMAÑO SIZE	Ø INT. Ø INNER	Referencia Part n°	€
1/2"	18.64	18.64X3.53	0,26
3/4"	24.99	24.99X3.53	0,35
1"	32.92	32.92X3.53	0,46
1"1/4	37.70	37.70X3.53	0,54
1"1/2	47.22	47.22X3.53	0,71
2"	56.74	56.74X3.53	0,82

Juntas para bridas SAE 3000/6000 PSI

Seals for 3000/6000 PSI flange

Joint pour bride série 3000/6000

Guarnizioni per flangia SAE 3000/6000 PSI



TAMAÑO SIZE	Ø INT. Ø INNER	Ø EXT. Ø OUTER	Referencia Part n°	€
1/2"	17.02	25.40	JBR08	0,94
3/4"	23.36	31.72	JBR12	1,27
1"	31.24	39.62	JBR16	1,45
1"1/4	36.07	44.45	JBR20	2,00
1"1/2	45.34	53.98	JBR24	2,35
2"	54.86	63.50	JBR32	2,52

CONEXIONES SERIE STANDARD

Standard series fittings
Embouts série Standard
Raccordi serie Standard

Macho pistola hidrolavadora

Male terminal steel hydro-wash

Mâle fixe spécial pistolet-hydronetoyage

Maschio pistola idropulitrice



DN	Referencia Part n°	€
1/4"	230400400	1,71

Empuñaduras de goma negras

Handle in black rubber

Poignée hydronetoyage de gomme noire

Manopola di gomma nera



DN	Ø EXT. Ø OUTER	Ø INT. Ø INNER	Referencia Part n°	€
1/4"	29	15,5	230600400	1,90
5/16"	35	18	230600500	2,35
3/8"	35	21	230600600	2,14

Empuñaduras de goma grises

Handle with grey rubber

Poignée hydronetoyage de gomme grise

Manopola di gomma grigia



DN	Ø EXT. Ø OUTER	Ø INT. Ø INNER	Referencia Part n°	€
1/4"	29	15,5	230610400*	2,78
3/8"	35	22	230610600*	3,42

Hasta fin de existencias / Until end of stock / Jusqu'à la fin du stock / Fino ad esaurimento

Terminal Karcher acero

Swivel female hydro-wash

Embout femelle tournante acier spécial hydronetoyage

Femmina in acciaio per idropultrici



DN	ROSCA THREAD	DESCRIPCIÓN DESCRIPTION	Referencia Part n°	€
1/4"	M22X1.5	STD	230700400	6,14
5/16"	M22X1.5	STD	230700500	6,01
3/8"	M22X1.5	STD	230700600	6,06
1/4"	M22X1.5	LONG	230720400	6,14
5/16"	M22X1.5	LONG	230720500	6,07
3/8"	M22X1.5	LONG	230720600	6,07

Empuñaduras de goma azules

Handle in blue rubber

Poignée hydronetoyage de gomme bleue

Manopola di gomma azzurra



DN	Ø EXT. Ø OUTER	Ø INT. Ø INNER	Referencia Part n°	€
1/4"	29	15,5	230620400	2,90
5/16"	35	18	230620500	3,59
3/8"	35	21	230620600	3,18

Hembras giratorias racor CO2 W21.8

Swivel female CO2 fitting W21.8

Raccord CO2 femelle tournante W21.8

Raccordo CO2 femmina girevole W21.8



DN	ROSCA THREAD	Referencia Part n°	€
3/8"	W 21,8 14h	2470421806	3,46
1/2"	W 21,8 14h	2470421808	3,46



CONEXIONES SERIE REUSABLES

Reusable series fittings
Embouts Récuperables
Raccordi serie Recuperabile

Casquillos R1AT

Ferrules R1AT/1SN

Jupes à visser R1AT/1SN

Boccola R1AT/1SN



DN	Referencia Part n°	€
1/4"	A1G-4 R1T	6,37
3/8"	A1G-6 R1T	7,05
1/2"	A1G-8 R1T	10,72
3/4"	A1G-12 R1T	16,93
1"	A1G-16 R1T	27,76

Casquillos R2AT

Ferrules R2AT/2SN

Jupes à visser R2AT/2SN

Boccola R2AT/2SN



DN	Referencia Part n°	€
1/4"	A1G-4 R2T	5,96
3/8"	A1G-6 R2T	6,64
1/2"	A1G-8 R2T	8,98
5/8"	A1G-10 R2T	6,64
3/4"	A1G-12 R2T	9,30
1"	A1G-16 R2T	17,42

Hembras giratorias rectas BSP cono 60°

BSP Swivel female 60° cone

Femelle tournante gaz cyl BSP 60°

Femmina diritta recuperabile BSP sede 60°



DN	ROSCA THREAD	Referencia Part n°	€
1/4"	1/4" BSP	A3G-4	4,49
5/16"	3/8" BSP	A3G-6-5	5,54
3/8"	3/8" BSP	A3G-6	5,83
1/2"	1/2" BSP	A3G-8	9,10
3/4"	3/4" BSP	A3G-12	10,25
1"	1" BSP	A3G-16	20,69

Hembras giratorias 90° BSP cono 60°

BSP Swept 90° elbow 60° cone

Femelle tournante coude 90° gaz cyl BSP 60°

Femmina a 90° recuperabile BSP sede 60°



DN	ROSCA THREAD	Referencia Part n°	€
1/4"	1/4" BSP	A90G-4	6,54
3/8"	3/8" BSP	A90G-6	8,18
1/2"	1/2" BSP	A90G-8	12,20
1/2"	3/4" BSP	A90G-12-8*	15,98
3/4"	3/4" BSP	A90G-12	19,70
1"	1" BSP	A90G-16	36,46

Hasta fin de existencias / Until end of stock / Jusqu'à la fin du stock / Fino ad esaurimento

Machos rosca cilíndrica BSP cono 60°

BSP Male parallel 60° cone

Mâle gaz cyl BSP 60°

Maschio cilindrico recuperabile BSP sede 60°



DN	ROSCA THREAD	Referencia Part n°	€
1/4"	1/4" BSP	A2G-4	3,61
3/8"	3/8" BSP	A2G-6	5,28
1/2"	1/2" BSP	A2G-8	7,11
3/4"	3/4" BSP	A2G-12	9,71
1"	1" BSP	A2G-16	17,84

Hasta fin de existencias / Until end of stock / Jusqu'à la fin du stock / Fino ad esaurimento

Espigas lisas Métricas

Metric Standpipe

Embout lisse Métrique

Estremità tubolare Metrica recuperabile



DN	TUBO PIPE	Referencia Part n°	€
1/4"	6	AE 6-4	4,40
1/4"	8	AE 8-4	2,55
1/4"	10	AE 10-4	2,79
3/8"	10	AE 10-6	3,82
3/8"	12	AE 12-6	3,82
1/2"	15	AE 15-8	6,90
3/4"	22	AE 22-12*	26,70

Hembras giratorias rectas reusables rosca JIC cono 37°

Reusable JIC 37° straight swivel female

Femelle droite récupérable JIC 37°

Femmina diritta JIC sede 37° recuperabile



DN	ROSCA THREAD	Referencia Part n°	€
1/4"	7/16" 20h JIC	A3J-07-04	4,01
3/8"	9/16" 18h JIC	A3J-09-06	4,09
1/2"	3/4" 16h JIC	A3J-12-08	7,18
1/2"	7/8" 14h JIC	A3J-14-08	5,62
5/8"	7/8" 14h JIC	A3J-14-10	7,48
3/4"	1"1/16 12h JIC	A3J-17-12	10,51
1"	1"5/16 12h JIC	A3J-21-16	17,23

Machos reusables rosca JIC cono 37°

Reusable JIC 37° cone male

Mâle récupérables JIC cône 37°

Maschio JIC 37° recuperabile



DN	ROSCA THREAD	Referencia Part n°	€
1/2"	3/4" 16h JIC	A2J-12-08	*
3/4"	1"1/16 12h JIC	A2J-17-12	*
1"	1"5/16 12h JIC	A2J-21-16	*

*Consultar / On request / Sur demande / Su richiesta

CONEXIONES SERIE BW NO PELAR R12 / 4SP / 4SH

BW fittings - no skiving R12 / 4SP / 4SH
 Embouts BW sans dénuder R12 / 4SP / 4SH
 Raccordi BW - senza pelatura R12 / 4SP / 4SH

 **R13 - Ø 3/4" - 1"**

Casquillos R12/ 4SP/ 4SH serie BW

Ferrules R12/4SP/4SH BW series

Jupes à sertir R12/4SP/4SH série BW

Boccole pressare R12/4SP/4SH serie BW



DN	Referencia Part n°	€
3/4"	AC680101200*	11,11
1"	AC680101600*	13,79
1" 1/4	AC680102000*	22,98

Hasta fin de existencias / Until end of stock / Jusqu'à la fin du stock / Fino ad esaurimento

Casquillos R13/R15 para serie BW/BW+

Ferrules R13/R15 for fittings BW/BW+ series

Jupes R13/R15 pour embouts série BW/BW+

Boccole a pressare per R13/R15 per raccordi serie BW/BW+

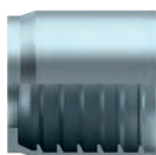

NEW

DN	Referencia Part n°	€
1" 1/4	AC690102000	*
1" 1/2	AC690102400	*
2"	AC690103200	*

Hembras giratorias rectas BSP cono 60° con junta

BSP Swivel female 60° cone with o'ring

Femelle tournante gaz cyl BSP 60° avec joint

Femmina diritta BSP sede 60° con o'ring



DN	ROSCA THREAD	Referencia Part n°	€
3/4"	3/4" BSP	661101212*	6,88
1"	1" BSP	661101616*	12,48
1" 1/4	1" 1/4 BSP	661102020*	18,68
1" 1/2	1" 1/2 BSP	NEW 661102424	36,14
2"	2" BSP	NEW 661103232	57,48

Hasta fin de existencias / Until end of stock / Jusqu'à la fin du stock / Fino ad esaurimento

Hembras giratorias 90° BSP cono 60° con junta

BSP Swivel female 60° cone with joint (90° Elbow)

Coude 90° femelle tournante gaz cyl BSP 60° avec joint

Femmina a 90° BSP sede 60° con o'ring



DN	ROSCA THREAD	Referencia Part n°	€
3/4"	3/4" BSP	661171212*	11,56
1"	1" BSP	661171616*	21,74
1" 1/4	1" 1/4 BSP	661172020*	34,46
1" 1/2	1" 1/2 BSP	NEW 661172424	60,90
2"	2" BSP	NEW 661173232	88,37

Hasta fin de existencias / Until end of stock / Jusqu'à la fin du stock / Fino ad esaurimento

Hembras giratorias 45° BSP cono 60° con junta

BSP Swivel female 60° cone with joint (45° Elbow)

Coude 45° femelle tournante gaz cyl BSP 60° avec joint

Femmina a 45° BSP sede 60° con o'ring



DN	ROSCA THREAD	Referencia Part n°	€
3/4"	3/4" BSP	661181212*	14,02
1"	1" BSP	661181616*	27,03
1" 1/4	1" 1/4 BSP	661182020*	35,98
1" 1/2	1" 1/2 BSP	NEW 661182424	56,15
2"	2" BSP	NEW 661183232	88,37

Hasta fin de existencias / Until end of stock / Jusqu'à la fin du stock / Fino ad esaurimento

Macho BSP cono 60°

BSP Male 60° cone

Mâle BSP cône 60°

Maschio BSP 60°



DN	ROSCA THREAD	Referencia Part n°	€
3/4"	3/4" BSP	661121212*	7,92
1"	1" BSP	661121616*	11,38
1" 1/4	1" 1/4 BSP	661122020*	18,68
1" 1/2	1" 1/2 BSP	NEW 661122424	40,60
2"	2" BSP	NEW 661123232	58,84

Hasta fin de existencias / Until end of stock / Jusqu'à la fin du stock / Fino ad esaurimento

CONEXIONES SERIE BW NO PELAR R12 / 4SP / 4SH

BW fittings - no skiving R12 / 4SP / 4SH
 Embouts BW sans dénuder R12 / 4SP / 4SH
 Raccordi BW - senza pelatura R12 / 4SP / 4SH

Macho JIC 37°

JIC 37° male

Mâle JIC 37°

Maschio JIC 37°



DN	ROSCA THREAD	Referencia Part n°	€
3/4"	1"1/16 12h UNF	661401712*	7,92
1"	1"5/16 12h UNF	661402116*	12,90
1" 1/4	1"5/8 12h UNF	NEW 661402620	24,27
1"1/2	1"7/8 12 UNF	NEW 661403024	34,49
2"	2" 1/2 12 UNF	NEW 661404032	57,48

Hasta fin de existencias / Until end of stock / Jusqu'à la fin du stock / Fino ad esaurimento

Hembras giratorias rectas JIC 37° doble hexagonal

JIC 37° Swivel female doble hexagonal

Femelle JIC 37° double hexagonale

Femmina diritta JIC 37° doppio esagono



DN	ROSCA THREAD	Referencia Part n°	€
3/4"	1"1/16 12h UNF	662421712*	*
1"	1"5/16 12h UNF	662422116*	*
1" 1/4	1"5/8 12h UNF	NEW 662422620	*
1"1/2	1"7/8 12 UNF	NEW 662423024	*
2"	2" 1/2 12 UNF	NEW 662424032	*

Hasta fin de existencias / Until end of stock / Jusqu'à la fin du stock / Fino ad esaurimento

Hembras giratorias 90° JIC 37°

JIC 37° swivel female (90° Elbow)

Coude 90° femelle JIC 37°

Femmina gir. 90° JIC 37°



DN	ROSCA THREAD	Referencia Part n°	€
3/4"	1"1/16 12h UNF	661381712*	14,46
1"	1"5/16 12h UNF	661382116*	25,14
1" 1/4	1"5/8 12h UNF	NEW 661382620	*
1"1/2	1"7/8 12 UNF	NEW 661383024	54,26
2"	2" 1/2 12 UNF	NEW 661384032	87,84

Hasta fin de existencias / Until end of stock / Jusqu'à la fin du stock / Fino ad esaurimento

Hembras giratorias 45° JIC 37°

JIC 37° swivel female (45° Elbow)

Coude 45° femelle JIC 37°

Femmina gir. 45° JIC 37°



DN	ROSCA THREAD	Referencia Part n°	€
3/4"	1"1/16 12h UNF	661391712*	14,02
1"	1"5/16 12h UNF	661392116*	23,62
1" 1/4	1"5/8 12h UNF	NEW 661392620	*
1"1/2	1"7/8 12 UNF	NEW 661393024	54,26
2"	2" 1/2 12 UNF	NEW 661394032	100,93

Hasta fin de existencias / Until end of stock / Jusqu'à la fin du stock / Fino ad esaurimento

Hembras giratorias 90° Métricas cono 24° con junta tórica

Metric swivel female 24° seat with o'ring (90° Elbow)

Coude 90° femelle Métrique 24° avec o'ring

Femmina Metrica 90° sede 24° con o'ring



DN	ROSCA THREAD	Referencia Part n°	€
3/4"	M36X2	66205362512	21,34
1"	M42X2	66205423016	23,04
1"1/4	M52X2	66205523820	43,16

Hasta fin de existencias / Until end of stock / Jusqu'à la fin du stock / Fino ad esaurimento

Hembras giratorias 45° Métricas cono 24° con junta tórica

Metric swivel female 24° seat with o'ring (45° Elbow)

Coude 45° femelle Métrique 24° avec o'ring

Femmina Metrica 45° sede 24° con o'ring



DN	ROSCA THREAD	Referencia Part n°	€
3/4"	M36X2	66206362512*	19,64
1"	M42X2	66206423016*	24,35
1"1/4	M52X2	66206523820*	49,61

Hasta fin de existencias / Until end of stock / Jusqu'à la fin du stock / Fino ad esaurimento

Machos fijos Métricos cono 24°

Metric male stud 24° cono

Mâle Métrique cono 24°

Maschio Metrico sede 24°



DN	ROSCA THREAD	Referencia Part n°	€
3/4"	M36X2	66203362512*	11,92
1"	M42X2	66203423016*	19,46

Hasta fin de existencias / Until end of stock / Jusqu'à la fin du stock / Fino ad esaurimento

Hembras giratorias Métricas cono 24° con junta tórica

Metric swivel female 24° seat with o'ring

Femelle Métrique 24° avec o'ring

Femmina Metrica sede 24° con o'ring

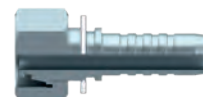

DN	ROSCA THREAD	Referencia Part n°	€
3/4"	M36X2	66204362512*	9,44
1"	M42X2	66204423016*	19,66

Hasta fin de existencias / Until end of stock / Jusqu'à la fin du stock / Fino ad esaurimento

CONEXIONES SERIE BW NO PELAR R12 / 4SP / 4SH

BW fittings - no skiving R12 / 4SP / 4SH
 Embouts BW sans dénuder R12 / 4SP / 4SH
 Raccordi BW - senza pelatura R12 / 4SP / 4SH

Brida recta SAE 3000 PSI

3000 PSI SAE Straight flange

Bride SAE droite série 3000 PSI

Flangia diritta SAE 3000



DN	∅	Referencia Part n°	€
3/4"	38.1	661821212*	11,78
1"	44.5	661821616*	18,03
1"1/4	50.8	661822020*	27,07

Hasta fin de existencias / Until end of stock / Jusqu'à la fin du stock / Fino ad esaurimento

Brida a 45° SAE 3000 PSI

3000 PSI SAE 45° Flange

Bride SAE coude 45° série 3000 PSI

Flangia 45° SAE 3000



DN	∅	Referencia Part n°	€
3/4"	38.1	661841212*	17,75
1"	44.5	661841616*	26,66
1"1/4	50.8	661842020*	39,96

Hasta fin de existencias / Until end of stock / Jusqu'à la fin du stock / Fino ad esaurimento

Brida a 90° SAE 3000 PSI

3000 PSI SAE 90° Flange

Bride SAE coude 90° série 3000 PSI

Flangia 90° SAE 3000



DN	∅	Referencia Part n°	€
3/4"	38.1	661831212*	17,74
1"	44.5	661831616*	22,18
1"1/4	50.8	661832020*	33,79

Hasta fin de existencias / Until end of stock / Jusqu'à la fin du stock / Fino ad esaurimento

FLUIDAL

CONEXIONES SERIE BW NO PELAR R12 / 4SP / 4SH

BW fittings - no skiving R12 / 4SP / 4SH
 Embouts BW sans dénuder R12 / 4SP / 4SH
 Raccordi BW - senza pelatura R12 / 4SP / 4SH

Brida recta SAE 6000 PSI

6000 PSI SAE Straight flange

Bride SAE droite série 6000 PSI

Flangia diritta SAE 6000



DN	Ø	Referencia Part n°	€
3/4"	41,3	662821212*	10,93
1"	47,6	662821616*	19,78
1"1/4	54	662822020*	31,18
1"1/2	63,5	NEW 662822424	44,16
2"	79,4	NEW 662823232	127,90

Hasta fin de existencias / Until end of stock / Jusqu'à la fin du stock / Fino ad esaurimento

Brida a 90° SAE 6000 PSI

6000 PSI SAE 90° Flange

Bride SAE coude 90° série 6000 PSI

Flangia 90° SAE 6000



DN	Ø	Referencia Part n°	€
3/4"	41,3	662831212*	17,70
1"	47,6	662831616*	28,00
1"1/4	54	662832020*	37,08
1"1/2	63,5	NEW 662832424	80,29
2"	79,4	NEW 662833232	186,16

Hasta fin de existencias / Until end of stock / Jusqu'à la fin du stock / Fino ad esaurimento

Brida a 45° SAE 6000 PSI

6000 PSI SAE 45° flange

Bride SAE coude 45° série 6000 PSI

Flangia 45° SAE 6000



DN	Ø	Referencia Part n°	€
3/4"	41,3	662841212*	15,46
1"	47,6	662841616*	23,27
1"1/4	54	662842020*	40,52
1"1/2	63,5	NEW 662842424	69,86
2"	79,4	NEW 662843232	150,18

Hasta fin de existencias / Until end of stock / Jusqu'à la fin du stock / Fino ad esaurimento

Hembra giratoria recta ORFS asiento plano doble hexagonal

ORFS Swivel female straight double hexagonal

Femelle droite ORFS double hexagonale

Femmina diritta ORFS doppio esagono



DN	ROSCA THREAD	Referencia Part n°	€
3/4"	1"3/16 12h UNF	669011212*	8,43
1" 1/4	1"11/16 12h UNF	NEW 669012020	999,00
1" 1/2	2" 12h UNF	NEW 669012424	999,00

Hasta fin de existencias / Until end of stock / Jusqu'à la fin du stock / Fino ad esaurimento

Hembra giratoria 90° ORFS asiento plano

ORFS Swivel female (90° Elbow)

Coude 90° femelle ORFS

Femmina 90° ORFS



DN	ROSCA THREAD	Referencia Part n°	€
3/4"	1"3/16 12h UNF	669071212*	13,67
1"	1"7/16 12h UNF	669071616*	23,91
1" 1/4	1"11/16 12h UNF	NEW 669072020	*
1" 1/2	2" 12h UNF	NEW 669072424	*

Hasta fin de existencias / Until end of stock / Jusqu'à la fin du stock / Fino ad esaurimento

Hembra giratoria 45° ORFS asiento plano

ORFS Swivel female (45° Elbow)

Coude 45° femelle ORFS

Femmina 45° ORFS



DN	ROSCA THREAD	Referencia Part n°	€
3/4"	1"3/16 12h UNF	669081212*	15,96
1"	1"7/16 12h UNF	669081616*	27,57
	1"11/16 12h UNF	NEW 669082020	*
	2" 12h UNF	NEW 669082424	*

Hasta fin de existencias / Until end of stock / Jusqu'à la fin du stock / Fino ad esaurimento

CONEXIONES SERIE INTERLOCK

Interlock series fittings
Emboutis à sertir Interlock
Raccordi serie Interlock

Casquillos 4SH

Ferrules DIN 20023-4SH

Jupe à sertir DIN 20023 4SH

Boccola Interlock 4SH



DN	MANGUERA HOSE	Referencia Part n°	€
3/4"	4SH / R13 / R15	A610101200	9,40
1"	4SH / R13 / R15	A610101600	17,34
1"1/4	4SH	A610102000	24,85
1"1/2	4SH	A610102400	58,02
2"	4SH	A610103200	57,04

Casquillos R13-R15

Ferrules SAE 100 R13/R15

Jupe à sertir DIN 20023 R13/R15

Boccola Interlock R13/R15

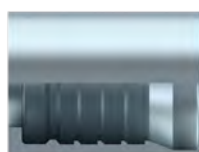

DN	MANGUERA HOSE	Referencia Part n°	€
1"1/4	R13/R15	610102000	29,54
1"1/2	R13/R15	610102400	42,04
2"	R13	610103200	70,56

Hembras giratorias rectas BSP cono 60° con junta

BSP Swivel female 60° cone + o'ring

Femelle tournante gaz cyl BSP 60° + o'ring

Femmina diritta BSP sede 60° con o'ring



DN	ROSCA THREAD	Referencia Part n°	€
3/4"	3/4" BSP	641001212	7,84
1"	1" BSP	641001616	14,23
1"1/2	1"1/2 BSP	641002424	41,20

Hasta fin de existencias / Until end of stock / Jusqu'à la fin du stock / Fino ad esaurimento

Hembras giratorias 90° BSP cono 60° con junta

BSP Swivel female 60° cone + o'ring (90° Elbow)

Femelle tournante coude 90° gaz cyl BSP 60° + o'ring

Femmina a 90° BSP sede 60° con o'ring



DN	ROSCA THREAD	Referencia Part n°	€
1"	1" BSP	641071616	24,78
1"1/4	1"1/4 BSP	641072020	39,28
1"1/2	1"1/2 BSP	641072424	69,42
2"	2" BSP	641073232	100,74

Hasta fin de existencias / Until end of stock / Jusqu'à la fin du stock / Fino ad esaurimento

Hembras giratorias 45° BSP cono 60° con junta

BSP Swivel female 60° cone + o'ring (45° Elbow)

Femelle tournante coude 45° gaz cyl BSP 60° + o'ring

Femmina a 45° BSP sede 60° con o'ring



DN	ROSCA THREAD	Referencia Part n°	€
3/4"	3/4" BSP	641081212	15,98
1"	1" BSP	641081616	30,82
1"1/2	1"1/2 BSP	641082424	64,02
2"	2" BSP	641083232	100,74

Hasta fin de existencias / Until end of stock / Jusqu'à la fin du stock / Fino ad esaurimento

Macho rosca cilíndrica BSP cono 60°

BSP Male 60° cone

Mâle fixe gaz cyl BSP 60°

Maschio cilindrico BSP sede 60°



DN	ROSCA THREAD	Referencia Part n°	€
3/4"	3/4" BSP	641121212	8,50
1"	1" BSP	641121616	19,39
1"1/4	1"1/4 BSP	641122020	21,67
1"1/2	1"1/2 BSP	641122424	46,28
2"	2" BSP	641123232	67,08

Macho rosca NPT

NPT Male

Mâle fixe NPT

Maschio conico NPT



DN	ROSCA THREAD	Referencia Part n°	€
3/4"	3/4" NPT	641611212	7,96
1"	1" NPT	641611616	14,26
1"1/4	1"1/4 NPT	641612020	25,26
1"1/2	1"1/2 NPT	641612424	39,82
2"	2" NPT	641613232	60,92

CONEXIONES SERIE INTERLOCK

Interlock series fittings
Embouts à sertir Interlock
Raccordi serie Interlock

Hembras giratorias rectas BSP cono 60° con junta (tuerca engargolada) **NEW**

BSP Swivel female 60° cone + o'ring wired nut

Femelle tournante gaz cyl BSP 60° + o'ring écrou à joint

Femmina diritta BSP sede 60° con o'ring dado spinato



DN	ROSCA THREAD	Referencia Part n°	€
3/4"	3/4" BSP	645001212	8,85
1"	1" BSP	645001616	16,05
1"1/4	1"1/4 BSP	645002020	24,02
1"1/2	1"1/2 BSP	645002424	24,38
2"	2" BSP	645003232	63,21

Hembras giratorias 45° BSP cono 60° con junta (tuerca engargolada) **NEW**

BSP Swivel female 60° cone + o'ring (45° Elbow) wired nut

Femelle tournante coude 45° gaz cyl BSP 60° + o'ring écrou à joint

Femmina a 45° BSP sede 60° con o'ring dado spinato



DN	ROSCA THREAD	Referencia Part n°	€
3/4"	3/4" BSP	645081212	18,20
1"	1" BSP	645081616	33,50
1"1/4	1"1/4 BSP	645082020	45,39
1"1/2	1"1/2 BSP	645082424	70,00
2"	2" BSP	645083232	112,14

Hembras giratorias 90° BSP cono 60° con junta (tuerca engargolada) **NEW**

BSP Swivel female 60° cone + o'ring (90° Elbow) wired nut

Femelle tournante coude 90° gaz cyl BSP 60° + o'ring écrou à joint

Femmina a 90° BSP sede 60° con o'ring dado spinato



DN	ROSCA THREAD	Referencia Part n°	€
3/4"	3/4" BSP	645071212	14,02
1"	1" BSP	645071616	26,25
1"1/4	1"1/4 BSP	645072020	41,77
1"1/2	1"1/2 BSP	645072424	74,61
2"	2" BSP	645073232	99,84

FLUIDAL

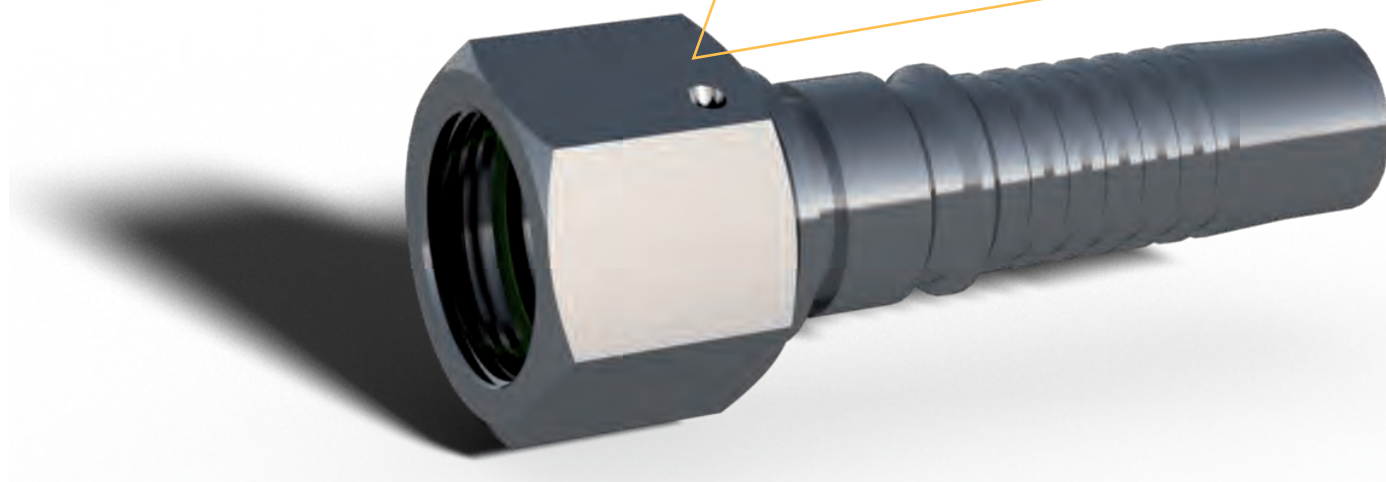
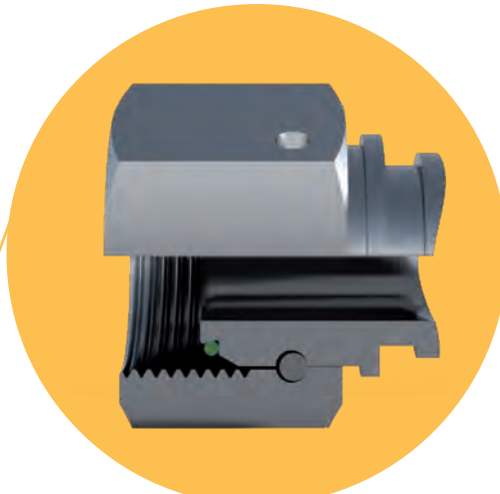

CONEXIONES SERIE INTERLOCK

Interlock series fittings
Emboutis à sertir Interlock
Raccordi serie Interlock

Hembras giratorias rectas JIC 37º

JIC 37º Swivel female

Femelle tournante JIC 37º

Femmina diritta JIC 37º



DN	ROSCA THREAD	Referencia Part nº	€
1"1/2	1"7/8 12h UNF	641423024	37,52
2"	2"1/2 12h UNF	641424032	71,91

Hasta fin de existencias / Until end of stock / Jusqu'à la fin du stock / Fino ad esaurimento

Hembras giratorias 90º JIC 37º

JIC 37º Swivel female (90º Elbow)

Femelle tournante coude 90º JIC 37º

Femmina a 90º JIC 37º



DN	ROSCA THREAD	Referencia Part nº	€
3/4"	1"1/16 12h UNF	641381712	16,48
1"	1"5/16 12h UNF	641382116	28,66
1"1/4	1"5/8 12h UNF	641382620	31,19
1"1/2	1"7/8 12h UNF	641383024	61,85
2"	2"1/2 12h UNF	641384032	100,13

Hasta fin de existencias / Until end of stock / Jusqu'à la fin du stock / Fino ad esaurimento

Hembras giratorias 45º JIC 37º

JIC 37º Swivel female (45º Elbow)

Femelle tournante coude 45º JIC 37º

Femmina a 45º JIC 37º



DN	ROSCA THREAD	Referencia Part nº	€
3/4"	1"1/16 12h UNF	641391712	15,98
1"	1"5/16 12h UNF	641392116	26,93
1"1/4	1"5/8 12h UNF	641392620	44,12
1"1/2	1"7/8 12h UNF	641393024	61,85
2"	2"1/2 12h UNF	641394032	115,06

Hasta fin de existencias / Until end of stock / Jusqu'à la fin du stock / Fino ad esaurimento

Macho JIC 37º

JIC 37º male

Mâle fixe JIC 37º

Maschio JIC 37º



DN	ROSCA THREAD	Referencia Part nº	€
3/4"	1"1/16 12h UNF	641401712	9,19
1"	1"5/16 12h UNF	641402116	14,71
1"1/4	1"5/8 12h UNF	641402620	24,28
1"1/2	1"7/8 12h UNF	641403024	40,01
2"	2"1/2 12h UNF	641404032	65,53

Hembras giratorias rectas JIC 37º (Engargolada)

NEW

JIC 37º Swivel female wired nut

Femelle tournante JIC 37º écrou à joint

Femmina diritta JIC 37º dado spinato



ROSCA THREAD	DN	Referencia Part nº	€
1"1/16 12 UN	3/4"	645421712	7,84
1"5/16 12 UN	1"	645422116	16,05
1"5/8 12 UN	1"1/4	645422620	22,98
1"7/8 12 UN	1"1/2	645423024	41,03
2"1/2 12 UN	2"	645424032	77,28

Hembras giratorias 90º JIC 37º (Engargolada)

NEW

JIC 37º Swivel female (90º Elbow) wired nut

Femelle tournante coude 90º JIC 37º écrou à joint

Femmina a 90º JIC 37º dado spinato



DN	ROSCA THREAD	Referencia Part nº	€
3/4"	1"1/16 12h UNF	645381712	20,37
1"	1"5/16 12h UNF	645382116	31,34
1"1/4	1"5/8 12h UNF	645382620	35,52
1"1/2	1"7/8 12h UNF	645383024	63,21
2"	2"1/2 12h UNF	645384032	120,96

Hembras giratorias 45º JIC 37º (Engargolada)

NEW

JIC 37º Swivel female (45º Elbow) wired nut

Femelle tournante coude 45º JIC 37º écrou à joint

Femmina a 45º JIC 37º dado spinato



DN	ROSCA THREAD	Referencia Part nº	€
3/4"	1"1/16 12h UNF	645391712	17,17
1"	1"5/16 12h UNF	645392116	29,44
1"1/4	1"5/8 12h UNF	645392620	47,42
1"1/2	1"7/8 12h UNF	645393024	66,47
2"	2"1/2 12h UNF	645394032	123,65

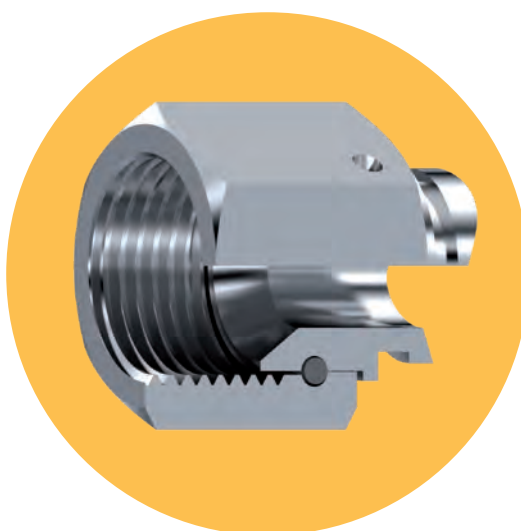

CONEXIONES SERIE INTERLOCK

Interlock series fittings
Embouts à sertir Interlock
Raccordi serie Interlock

Hembra giratoria recta Métrica con 24° con junta tórica

Metric swivel female 24° seat with o'ring

Femelle tournante Métrique 24° + o'ring

Femmina Metrica sede 24° con o'ring

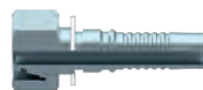

DN	TUBO PIPE	SERIE SERIES	ROSCA THREAD	Referencia Part n°	€
3/4"	20	S	M30X2	64204302012	10,18
3/4"	25	S	M36X2	64204362512	10,96
1"	25	S	M36X2	64204362516	16,61
1"	30	S	M42X2	64204423016	21,63
1"1/4	38	S	M52X2	64204523820	32,50

Hembra giratoria 45° Métrica con 24° con junta tórica

Metric swivel female 24° seat with o'ring (45° Elbow)

Femelle tournante coude 45° Métrique + o'ring

Femmina a 45° sede 24° con o'ring



DN	TUBO PIPE	SERIE SERIES	ROSCA THREAD	Referencia Part n°	€
3/4"	20	S	M30X2	64206302012	17,73
1"	30	S	M42X2	64206423016	28,25
1"1/4	38	S	M52X2	64206523820	56,55

Hembra giratoria 90° Métrica con 24° con junta tórica

Metric swivel female 24° seat with o'ring (90° Elbow)

Femelle tournante coude 90° Métrique + o'ring

Femmina a 90° Metrica sede 24° con o'ring

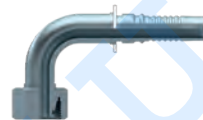

DN	TUBO PIPE	SERIE SERIES	ROSCA THREAD	Referencia Part n°	€
3/4"	20	S	M30X2	64205302012	18,28
3/4"	25	S	M36X2	64205362512	24,33
1"	30	S	M42X2	64205423016	26,73
1"1/4	38	S	M52X2	64205523820	49,20

Macho rosca Métrica cono 24°

Metric male stud 24° cone

Mâle fixe Métrique 24° série lourde

Maschio Metrico sede 24°



DN	TUBO PIPE	SERIE SERIES	ROSCA THREAD	Referencia Part n°	€
3/4"	20	S	M30X2	64203302012	9,35
3/4"	25	S	M36X2	64203362512	14,62
1"	30	S	M42X2	64203423016	22,58
1"1/4	38	S	M52X2	64203523820	32,44

Hembra giratoria recta Métrica cono 24° C/J martillos

Metric swivel female 24° seat with o'ring for hammer

Femelle tournante Métrique 24° + o'ring pour marteau

Femmina Metrica sede 24° con o'ring per martello



DN	TUBO PIPE	ROSCA THREAD	SERIE SERIES	Referencia Part n°	€
3/4"	25	M36X2	S	NAM362512	61,69
1"	30	M42X2	S	NAM423016	73,95
1"1/4	38	M52X2	S	NAM523820	87,20

Se venden con casquillo Interlock incluido (mismo diámetro de prensado que los casquillos A61010...) / With Interlock ferrule included (same crimping diameter as ferrule A61010) / Avec jupe Interlock incluse (même diamètre de sertissage que la jupe A61010) / Con boccola Interlock inclusa (diametro di pressatura uguale alla boccola A61010)

CONEXIONES SERIE INTERLOCK

Interlock series fittings
Embouts à sertir Interlock
Raccordi serie Interlock

Hembras rectas ORFS

ORFS Swivel female

Femelle droite ORFS

Femmina diritta ORFS Interlock



DN	ROSCA THREAD	Referencia Part n°	€
3/4"	1"3/16 12h UNF	649001212	11,79
1"	1"7/16 12h UNF	649001616	14,67
1"1/4	1"11/16 12h UNF	649002020	30,26
1"1/2	2" 12h UNF	649002424	34,09

Codos 90° ORFS

ORFS Swivel female (90° Elbow)

Coude 90° femelle ORFS

Curva a 90° ORFS Interlock



DN	ROSCA THREAD	Referencia Part n°	€
3/4"	1"3/16 12h UNF	649071212	18,60
1"	1"7/16 12h UNF	649071616	29,09
1"1/4	1"11/16 12h UNF	649072020	36,84
1"1/2	2" 12h UNF	649072424	54,86

Codos 45° ORFS

ORFS Swivel female (45° Elbow)

Coude 45° femelle ORFS

Curva a 45° ORFS Interlock



DN	ROSCA THREAD	Referencia Part n°	€
3/4"	1"3/16 12h UNF	649081212	16,98
1"	1"7/16 12h UNF	649081616	29,09
1"1/4	1"11/16 12h UNF	649082020	44,12

FLUIDAL

CONEXIONES SERIE INTERLOCK

Interlock series fittings
Embouts à sertir Interlock
Raccordi serie Interlock

Brida SAE 3000 PSI

3000 PSI SAE Straight Flange / Code 61

Bride SAE droite série 3000 PSI

Flangia SAE 3000 PSI



DN	∅	Referencia Part nº	€
3/4"	38.1	641821212	14,03
3/4"	44.5	641821612	18,76
1"	44.5	641821616	20,92
1"	50.8	641822016	26,29
1"1/4	50.8	641822020	31,40
1"1/4	60.3	641822420	44,92
1"1/2	60.3	641822424	54,24
2"	71.4	641823232	85,68

Brida SAE 6000 PSI

6000 PSI SAE Straight Flange / Code 62

Bride SAE droite série 6000 PSI

Flangia SAE 6000 PSI



DN	∅	Referencia Part nº	€
3/4"	41.3	642821212	12,68
3/4"	47.6	642821612	18,82
1"	47.6	642821616	22,94
1"	54	642822016	27,42
1"1/4	54	642822020	34,29
1"1/4	63.5	642822420	55,75
1"1/2	63.5	642822424	48,58
2"	79.4	642823232	97,09

Brida a 90º SAE 3000 PSI

3000 PSI SAE Flange (90º Elbow) / Code 61

Bride SAE coude 90º série 3000 PSI

Flangia a 90º SAE 3000 PSI



DN	∅	Referencia Part nº	€
3/4"	38.1	641831212	20,58
3/4"	44.5	641831612	27,63
1"	44.5	641831616	25,72
1"	50.8	641832016	39,07
1"1/4	50.8	641832020	40,68
1"1/4	60.3	641832420	58,63
1"1/2	60.3	641832424	69,17
2"	71.4	641833232	123,88

Brida a 90º SAE 6000 PSI

6000 PSI SAE Flange (90º Elbow) / Code 62

Bride SAE coude 90º série 6000 PSI

Flangia a 90º SAE 6000 PSI



DN	∅	Referencia Part nº	€
3/4"	41.3	642831212	20,53
3/4"	47.6	642831612	30,47
1"	47.6	642831616	32,47
1"	54	642832016	48,34
1"1/4	54	642832020	43,01
1"1/4	63.5	642832420	63,72
1"1/2	63.5	642832424	93,14
2"	79.4	642833232	215,95

Brida a 45º SAE 3000 PSI

3000 PSI SAE Flange (45º Elbow) / Code 61

Bride SAE coude 45º série 3000 PSI

Flangia a 45º SAE 3000 PSI



DN	∅	Referencia Part nº	€
3/4"	38.1	641841212	20,59
3/4"	44.5	641841612	26,69
1"	44.5	641841616	29,32
1"1/4	50.8	641842020	46,35
1"1/4	60.3	641842420	62,24
1"1/2	60.3	641842424	61,27
2"	71.4	641843232	145,16

Brida a 45º SAE 6000 PSI

6000 PSI SAE Flange (45º Elbow) / Code 62

Bride SAE coude 45º série 6000 PSI

Flangia a 45º SAE 6000 PSI



DN	∅	Referencia Part nº	€
3/4"	41.3	642841212	17,70
3/4"	47.6	642841612	20,96
1"	47.6	642841616	35,22
1"	54	642842016	29,28
1"1/4	54	642842020	49,95
1"1/2	63.5	642842424	81,04
2"	79.4	642843232	174,20

CONEXIONES SERIE INTERLOCK

Interlock series fittings
Emboutis à sertir Interlock
Raccordi serie Interlock

Brida 9000 PSI (14,3)

9000 PSI Straight flange (14,3)

Bride droite série 9000 PSI (14,3)

Flangia 9000 PSI (14,3)



DN	∅	Referencia Part nº	€
3/4"	41,3	643821212	19,02
1"	47,6	643821616	27,98
1"	54	643822016	37,82
1"1/4	54	643822020	34,16
1"1/4	63,5	643822420	56,94
1"1/2	63,5	643822424	45,24

Brida a 90º 9000 PSI (14,3)

90º 9000 PSI Flange (14,3)

Bride coude 90º série 9000 PSI (14,3)

Flangia a 90º 9000 PSI (14,3)



DN	∅	Referencia Part nº	€
3/4"	41,3	643831212	23,28
1"	47,6	643831616	42,03
1"	54	643832016	37,91
1"1/4	54	643832020	74,88
1"1/2	63,5	643832424	99,08

Brida a 45º 9000 PSI (14,3)

45º 9000 PSI Flange (14,3)

Bride coude 45º série 9000 PSI (14,3)

Flangia a 45º 9000 PSI (14,3)



DN	∅	Referencia Part nº	€
3/4"	41,3	643841212	22,47
1"	47,6	643841616	37,06
1"	54	643842016	50,23
1"1/4	54	643842020	52,84
1"1/2	63,5	643842424	86,33

FLUIDAL

CONEXIONES SERIE INTERLOCK

Interlock series fittings
Embout à sertir Interlock
Raccordi serie Interlock

Espiga para brida macho Poclair

Poclair male flange

Embout bride mâle Poclair

Inserto per flangia maschio Poclair 4SH



DN	Ø	Referencia Part n°	€
3/4"	3/4"	648011212	17,51
1"	1"	648011616	43,32
1"1/4	1"1/4	648012020	55,64

Hasta fin de existencias / Until end of stock / Jusqu'à la fin du stock / Fino ad esaurimento

Brida entera hembra Poclair 4 agujeros

Female Poclair flange 4 holes

Bride rectangulaire de fixation femelle Poclair-4 trous

Flangia intera femmina Poclair 4 fori



TAMAÑO SIZE	Referencia Part n°	€
3/4"	448061212	60,95
1"	448061616	69,33
1"1/4	448062020	86,51

Hasta fin de existencias / Until end of stock / Jusqu'à la fin du stock / Fino ad esaurimento

Brida entera macho Poclair 4 agujeros

Male Poclair flange 4 holes

Bride rectangulaire de fixation mâle Poclair-4 trous

Flangia intera maschio Poclair 4 fori



TAMAÑO SIZE	Referencia Part n°	€
3/4"	448051212	42,66
1"	448051616	50,86
1"1/4	448052020	67,56

Hasta fin de existencias / Until end of stock / Jusqu'à la fin du stock / Fino ad esaurimento

Brida entera macho Poclair 2 agujeros

Male Poclair flange 2 holes

Bride ovale fixation mâle Poclair 2 trous

Flangia intera maschio Poclair 2 fori



TAMAÑO SIZE	Referencia Part n°	€
5/8"	448071010	35,47
3/4"	448071212	34,77
1"	448071616	42,40
1"1/4	448072020	67,53

Hasta fin de existencias / Until end of stock / Jusqu'à la fin du stock / Fino ad esaurimento

Espiga para brida hembra Poclair

Poclair female flange

Embout bride femelle Poclair

Inserto per flangia femmina Poclair 4SH



DN	Ø	Referencia Part n°	€
3/4"	3/4"	648021212	33,68
1"	1"	648021616	34,78

Hasta fin de existencias / Until end of stock / Jusqu'à la fin du stock / Fino ad esaurimento

CONEXIONES ALTA PRESIÓN (700 BAR)

High pressure 700 Bar fittings
 Embouts haute pression 700 Bar
 Raccordi altissima pressione (700 Bar)

Manguera termoplástica 700 bar

Thermoplastic hose 700 bar

Tuyau thermoplastique haute pression 700 bar

Tubo termoplastico 700 bar



DN	Referencia Part n°	€
1/4"	MT70004	33,17
3/8"	MT70006	78,11

Casquillos manguera 700 bar tipo MT700

Ferrules for thermoplastic hose 700 bar MT700 type

Jupes à sertir thermoplastique 700 bar type MT700

Boccole per tubo termoplastico 700 bar tipo MT700



DN	Referencia Part n°	€
1/4"	710120400	2,31
3/8"	710120600	3,17

Hembra giratoria recta BSP 60º

BSP Swivel female 60° cone

Embout thermoplastique 700 bar femelle tournante gaz cyl BSP 60°

Femmina diritta BSP sede 60°



DN	ROSCA THREAD	Referencia Part n°	€
1/4"	1/4" BSP	741000404	5,50
3/8"	3/8" BSP	741000606	4,41

Macho BSP 60º

BSP Male parallel 60° cone

Embout thermoplastique 700 bar mâle fixe gaz cyl BSP 60°

Maschio cilindrico BSP sede 60°



DN	ROSCA THREAD	Referencia Part n°	€
1/4"	1/4" BSP	741120404	4,31
3/8"	3/8" BSP	741120606	5,10

Macho NPT

NPT Male thread

Embout thermoplastique 700 bar mâle fixe gaz conique NPT

Maschio conico NPT



DN	ROSCA THREAD	Referencia Part n°	€
1/4"	1/4" NPT	741610404	3,57
1/4"	3/8" NPT	741610604	3,57
3/8"	3/8" NPT	741610606	4,05

SERIE COMPACTA

One Piece Series

Série Pré-sertis

Serie Compatti

■ Conexiones compactas 1SC / 1SN / 2SC / R6 / 2TE

One piece fittings 1SC / 1SN / 2SC / R6 / 2TE

Embouts pré-sertis 1SC / 1SN / 2SC / R6 / 2TE

Raccordi compatti 1SC / 1SN / 2SC / R6 / 2TE

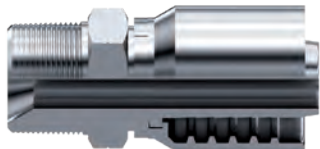

EN 857 1SC	EN 853 1 SN SAE 100 R1AT	EN 857 2SC	EN 854 SAE 100 R6	EN 854 2TE
---------------	-----------------------------------	---------------	-------------------------	---------------

■ Conexiones compactas Serie 43 R1AT / R2AT / 1SN / 2SN / R16 / 2SC / 3TE/R17

One piece fittings 43 Series R1AT / R2AT / 1SN / 2SN / R16 / 2SC / 3TE/R17

Embouts pré-sertis R1AT / R2AT / 1SN / 2SN / R16 / 2SC Série 43 / 2TE/ R17

Raccordi compatti R1AT / R2AT / 1SN / 2SN / R16 / 2SC Serie 43 / 3TE /R17



EN 853 1SN SAE 100R1AT	EN 853 2 SN SAE 100 R2AT	EN 857 2SC SAE 100 R16	SUPERSERVICE 155° 2SC	3TE
------------------------------	-----------------------------------	---------------------------------	-----------------------------	-----

■ Conexiones compactas Serie BWS NO PELAR 3SP / 4SP / 4SH / R12

One piece fittings Standar Series NON SKIVE 3SP / 4SP / 4SH / R12

Embouts pré-sertis SANS DÉNUDÉ 3SP / 4SP / 4SH / R12

Raccordi compatti SENZA PELATURA 3SP / 4SP / 4SH / R12

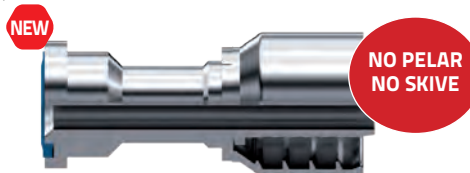

3SP	EN 856 4SP SAE 100 R9R	EN 856 4SH	EN856 R12 SAE 100	EN 856 R13 SAE 100	SAE 100 R15
3/4"-1"					

■ Conexiones compactas Serie BW+ NO PELAR R13 / R15

One piece fittings BW+ Series NON SKIVE R13 / R15

Embouts pré-sertis BW+ SANS DÉNUDÉ R13 / R15

Raccordi compatti BW+ SENZA PELATURA R13 / R15



EN 856 SAE 100 R13	SAE 100 R15
--------------------------	----------------

■ Conexiones compactas R7 / R8 y elastómero malla metálica

Piece fittings R7 / R8 & braid of steel wire

Embouts pré-sertis R7 / R8 et tresse métallique

Raccordi compatti serie R7 / R8 e elastomero treccia metallica



SAE 100 R7	SAE 100 R8	Metallic braid elastomer
---------------	---------------	--------------------------------

■ Conexiones compactas PTFE liso R14

One piece fittings for smooth PTFE R14

Embouts pré-sertis pour PTFE lisse R14

Raccordi compatti serie PTFE liscio R14



Smooth PTFE 1 braid

■ Conexiones compactas PTFE corrugado

One piece fittings for convoluted PTFE

Embouts pré-sertis pour PTFE convoluto

Raccordi compatti serie PTFE corrugato



Convoluted PTFE

■ Conexiones compactas Serie BW R12 / 4SP / 4SH

One piece fittings BW Series R12 / 4SP / 4SH

Embouts pré-sertis R12 / 4SP / 4SH Série BW

Raccordi compatti R12 / 4SP / 4SH Serie BW



EN 856 R12	EN 856 4SP	4 SH	R13 3/4" 1"
---------------	---------------	------	----------------

CONEXIONES SERIE 43 UNA SOLA PIEZA 1SN / R1AT / 2SN / R2AT / R16 / 2SC / 3TE / R17

One piece fittings 43 Series 1SN / R1AT / 2SN / R2AT / R16 / 2SC / 3TE / R17

Emboutis pré-sertis Série 43 1SN / R1AT / 2SN / R2AT / R16 / 2SC / 3TE / R17

Raccordi un pezzo Serie 43 1SN / R1AT / 2SN / R2AT / R16 / 2SC / 3TE / R17

Casquillos 1SC/1SN/2SC/R6/2TE/R17

Ferrules 1SC/1SN/2SC/R6/2TE/R17

Jupes à sertir 1SC/1SN/2SC/R6/2TE/R17

Boccole a pressare per 1SC/1SN/2SC/R6/2TE/R17



DN	Referencia Part n°	€
1/4"	SC21120400	1,49
5/16"	SC21120500	1,43
3/8"	SC21120600	1,63
1/2"	SC21120800	2,49
5/8"	SC21121000	3,38
3/4"	SC21121200	4,89
1"	SC21121600	7,58

Casquillos 1SN/2SN /R16/2SC/3TE/R17 para conexiones de una sola pieza serie 43

Ferrules 1SN/2SN/R16/2SC/3TE/R17 for one piece fittings 43 series

Jupes 1SN/2SN/R16/2SC/3TE/R17 pour embous pré-sertis série 43

Boccole a pressare 1SN/2SN/R16/2SN/3TE/R17 per raccordi compatti serie 43



DN	Referencia Part n°	€
1/4"	PFC221200400	1,54
5/16"	PFC221200500	2,03
3/8"	PFC221200600	2,03
1/2"	PFC221200800	2,36
5/8"	PFC221201000	3,54
3/4"	PFC221201200	6,13
1"	PFC221201600	7,86
1"1/4	PFC221202000	17,96
1"1/2	PFC221202400	25,58
2"	PFC221203200	42,45

Casquillos R12/3SP/4SP/4SH no pelar

Ferrules R12/3SP/4SP/4SH non skive

Jupes à sertir R12/3SP/4SP/4SH sans dénudage

Boccole a pressare per R12/ 3SP/4SP/4SH senza spellatura

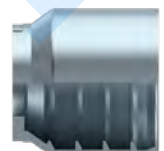

DN	Referencia Part n°	€
3/8"	DI222400600	2,27
1/2"	DI222400800	2,95
5/8"	DI222401000	4,30
3/4"	DI222401200	7,33
1"	DI222401600	8,72
1" 1/4	DI222402000	17,51
1" 1/2	DI222402400	33,40
2"	DI222403200	53,46

Casquillos R6, R7, R8 y malla metálica

Ferrules SAE 100 R6, R7, R8 and metallic braid

Jupes à sertir R6, R7, R8 et tresse métallique

Boccole a pressare per SAE R6, R7, R8 e Treccia Metallica



DN	Referencia Part n°	€
1/8"	DI2300200	1,25
3/16"	DI2300300	1,01
1/4"	DI2300400	1,03
5/16"	DI2300500	1,75
3/8"	DI2300600	1,55
1/2"	DI2300800	2,17
5/8"	DI2301000	3,40
3/4"	DI2301200	5,79
1"	DI2301600	9,52

Casquillos PTFE Liso alta presión SAE 100 R14 perfil liso

NEW

Ferrules for Smooth PTFE SAE 100 R14 smooth surface

Jupes à sertir pour PTFE Lisse haute pression SAE 100 R14 surface lisse

Boccole a pressare per tubo al PTFE Liscio alta pressione SAE 100 R14 superficie liscia



DN	Referencia Part n°	€
1/4"	280400400	1,33
5/16"	280400500	1,70
3/8"	280400600	1,53
1/2"	280400800	2,50
5/8"	280401000	2,85

Casquillos PTFE Corrugado alta presión perfil liso

NEW

Ferrules for Convolutated PTFE smooth surface

Jupes à sertir PTFE Convoluté haute pression surface lisse

Boccole a pressare per tubo al PTFE Corrugato alta pressione superficie liscia

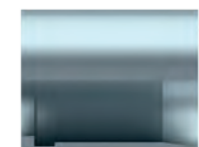

DN	Referencia Part n°	€
1/4"	280410400	1,41
3/8"	280410600	1,61
1/2"	280410800	2,02
5/8"	280411000	3,17
3/4"	280411200	3,62

CASQUILLOS UNA SOLA PIEZA

One piece fittings 43 Series 1SN / R1AT / 2SN / R2AT / R16 / 2SC / 3TE / R17
 Embouts pré-sertis Série 43 1SN / R1AT / 2SN / R2AT / R16 / 2SC / 3TE / R17
 Raccordi un pezzo Serie 43 1SN / R1AT / 2SN / R2AT / R16 / 2SC / 3TE / R17

Casquillos R12, 4SP, 4SH para conexiones de una sola pieza serie BW

Ferrules R12, 4SP, 4SH for fittings BW series

Jupes R12, 4SP, 4SH pour embouts série BW

Boccole pressare R12, 4SP, 4SH per raccordi serie BW



DN	Referencia Part n°	€
3/4"	AC680101200*	11,11
1"	AC680101600*	13,79
1" 1/4	AC680102000*	22,98

Casquillos R13/R15 para serie BW/BW+



Ferrules R13/R15 for fittings BW/BW+ series

Jupes R13/R15 pour embouts série BW/BW+

Boccole a pressare per R13/R15 per raccordi serie BW/BW+

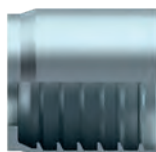

DN	Referencia Part n°	€
1"1/4	AC690102000	*
1"1/2	AC690102400	*
2"	AC690103200	*

FLUIDAL

*Consultar / On request / Sur demande / Su richiesta

CONEXIONES SERIE 43 UNA SOLA PIEZA 1SN / R1AT / 2SN / R2AT / R16 / 2SC / 3TE / R17

One piece fittings 43 Series 1SN / R1AT / 2SN / R2AT / R16 / 2SC / 3TE / R17
 Embouts pré-sertis Série 43 1SN / R1AT / 2SN / R2AT / R16 / 2SC / 3TE / R17
 Raccordi un pezzo Serie 43 1SN / R1AT / 2SN / R2AT / R16 / 2SC / 3TE / R17

Hembras giratorias rectas una sola pieza JIC 37º

One piece JIC 37º female

Femelle pré-sertie JIC 37º

Femmina diritta compatta JIC 37º



DN	ROSCA THREAD	Referencia Part nº	€
1/4"	7/16" 20h UNF	281420704	3,56
1/4"	1/2" 20h UNF	281420804	3,80
5/16"	1/2" 20h UNF	281420805	4,92
1/4"	9/16" 18h UNF	281420904	3,86
5/16"	9/16" 18h UNF	281420905	4,26
3/8"	9/16" 18h UNF	281420906	4,42
3/8"	5/8" 18h UNF	281421006	5,59
5/16"	3/4" 16h UNF	281421205	5,20
3/8"	3/4" 16h UNF	281421206	4,96
1/2"	3/4" 16h UNF	281421208	5,91
3/8"	7/8" 14h UNF	281421406	5,37
1/2"	7/8" 14h UNF	281421408	6,02
5/8"	7/8" 14h UNF	281421410	8,31
1/2"	1"1/16 12h UNF	281421708	7,65
5/8"	1"1/16 12h UNF	281421710	9,45
3/4"	1"1/16 12h UN	281421712	11,48
1"	1"1/16 12h UNF	281421716	18,27
3/4"	1"5/16 12h UNF	281422112	17,62
1"	1"5/16 12h UN	281422116	19,73
1"	1"5/8 12h UNF	281422616	26,11
1"1/4	1"5/8 12h UN	281422620	35,38
1" 1/4	1"7/8 12h UNF	281423020	52,20
1"1/2	1"7/8 12h UN	281423024	51,19
2"	2"1/2 12h UN	281424032	88,37

Machos una sola pieza rosca JIC 37º

One piece JIC 37º male

Mâle pré-serti JIC 37º

Maschio compatto JIC sede 37º



DN	ROSCA THREAD	Referencia Part nº	€
1/4"	7/16" 20h UNF	281400704	3,36
1/4"	1/2" 20 H UNF	281400804	4,54
5/16"	1/2" 20h UNF	281400805	4,97
1/4"	9/16" 18h UNF	281400904	3,54
5/16"	9/16" 18h UNF	281400905	4,58
3/8"	9/16" 18h UNF	281400906	4,16
3/8"	3/4" 16 h UNF	281401206	4,94
1/2"	3/4" 16h UNF	281401208	5,03
3/8"	7/8" 14h UNF	281401406	6,18
1/2"	7/8" 14h UNF	281401408	5,50
5/8"	7/8" 14h UNF	281401410	7,98
1/2"	1" 1/16 12h UNF	281401708	8,45
5/8	1" 1/16-12h UNF	281401710	9,19
3/4"	1"1/16 12h UN	281401712	13,31
3/4"	1" 5/16 12h UNF	281402112	16,53
1"	1"5/16 12h UN	281402116	20,43
1"	1" 5/8 12h UNF	281402616	27,98
1"1/4	1"5/8 12h UN	281402620	40,18
1" 1/4	1" 7/8 12h UNF	281403020	48,50
1"1/2	1"7/8 12h UN	281403024	56,11
2"	2"1/2 12h UN	281404032	98,41

Hembras giratorias rectas una sola pieza JIC 37º doble hexagonal

One piece back up hex JIC 37º female

Femelle pré-sertie JIC 37º double hexagonal

Femmina diritta JIC 37º doppio esagono



DN	ROSCA THREAD	Referencia Part nº	€
1/4"	7/16" 20h UNF	282420704	4,50
1/4"	1/2" 20h UNF	282420804	4,69
5/16"	9/16" 18h UNF	282420905	5,81
3/8"	9/16" 18h UNF	282420906	5,75
3/8"	3/4" 16h UNF	282421206	6,19
1/2"	3/4" 16h UNF	282421208	7,16
1/2"	7/8" 14h UNF	282421408	8,25
3/4"	1"1/16 12h UN	282421712	15,02
1"	1"5/16 12h UN	282422116	20,02
1"1/4	1"5/8 12h UN	282422620	43,46
1"1/2	1"7/8 12h UN	282423024	64,43
2"	2"1/2 12h UN	282424032	112,89

Hembras giratorias 90º una sola pieza JIC 37º

One piece JIC 37º Female (90º Elbow)

Coude 90º femelle pré-sertie JIC 37º

Femmina 90º compatta JIC 37º



DN	ROSCA THREAD	Referencia Part nº	€
1/4"	7/16" 20h UNF	281380704	5,04
1/4"	1/2" 20h UNF	281380804	5,21
1/4"	9/16" 18h UNF	281380904	4,86
5/16"	9/16" 18h UNF	281380905	6,40
3/8"	9/16" 18h UNF	281380906	6,91
3/8"	5/8" 18h UNF	281381006	7,78
3/8"	3/4" 16h UNF	281381206	6,79
1/2"	3/4" 16h UNF	281381208	6,91
3/8"	7/8" 14h UNF	281381406	10,48
1/2"	7/8" 14h UNF	281381408	8,50
5/8"	7/8" 14h UNF	281381410	12,85
1/2"	1"1/16 12h UNF	281381708	15,23
5/8"	1"1/16 12h UNF	281381710	14,81
3/4"	1"1/16 12h UN	281381712	16,69
3/4"	1"5/16 12h UNF	281382112	26,26
1"	1"5/16 12h UN	281382116	25,07
1"	1"5/8 12h UNF	281382616	42,46
1"1/4	1"5/8 12h UN	281382620	51,66
1" 1/4	1"7/8 12h UNF	281383020	71,75
1"1/2	1"7/8 12h UN	281383024	74,01
2"	2"1/2 12h UN	281384032	141,07

CONEXIONES SERIE 43 UNA SOLA PIEZA 1SN / R1AT / 2SN / R2AT / R16 / 2SC / 3TE / R17

One piece fittings 43 Series 1SN / R1AT / 2SN / R2AT / R16 / 2SC / 3TE / R17
 Embouts pré-sertis Série 43 1SN / R1AT / 2SN / R2AT / R16 / 2SC / 3TE / R17
 Raccordi un pezzo Serie 43 1SN / R1AT / 2SN / R2AT / R16 / 2SC / 3TE / R17

Hembras giratorias 45° una sola pieza JIC37°

One piece JIC 37° Female (45° Elbow)

Coude 45° femelle pré-sertie JIC 37°

Femmina 45° compatta JIC 37°



DN	ROSCA THREAD	Referencia Part n°	€
1/4"	7/16" 20h UNF	281390704	5,07
1/4"	1/2" 20h UNF	281390804	5,84
1/4"	9/16" 18h UNF	281390904	5,96
5/16"	9/16" 18h UNF	281390905	6,14
3/8"	9/16" 18h UNF	281390906	6,47
3/8"	3/4" 16h UNF	281391206	8,37
1/2"	3/4" 16h UNF	281391208	8,82
1/2"	7/8" 14h UNF	281391408	10,38
5/8"	7/8" 14h UNF	281391410	11,91
1/2"	1"1/16 12h UNF	281391708	14,82
5/8"	1"1/16 12h UNF	281391710	15,69
3/4"	1"1/16 12h UN	281391712	16,73
3/4"	1"5/16 12h UNF	281392112	27,22
1"	1"5/16 12h UN	281392116	25,60
1"	1"5/8 12h UNF	281392616	42,46
1"1/4	1"5/8 12h UN	281392620	55,78
1" 1/4	1"7/8 12h UNF	281393020	74,34
1"1/2	1"7/8 12h UN	281393024	81,95
2"	2"1/2 12h UN	281394032	144,63

Hembras giratorias rectas una sola pieza rosca NPSM cono 60°

One piece NPSM female 60° cone

Femelle pré-sertie NPSM cone 60°

Femmina diritta compatta NPSM sede 60°



DN	ROSCA THREAD	Referencia Part n°	€
1/4"	1/4" 18h NPSM	282610404	4,33
3/8"	3/8" 18h NPSM	282610606	5,34
1/2"	1/2" 14h NPSM	282610808	6,62
3/4"	3/4" 14h NPSM	282611212	12,74
1"	1" - 11 1/2 h NPSM	282611616	18,44

Machos una sola pieza rosca cónica NPT

One piece NPT male

Mâle pré-serti NPT

Maschio compatto conico NPT



DN	ROSCA THREAD	Referencia Part n°	€
1/4"	1/8" NPT	281610204	3,86
1/4"	1/4" NPT	281610404	3,99
5/16"	1/4" NPT	281610405	5,30
3/8"	1/4" NPT	281610406	5,30
1/4"	3/8" NPT	281610604	4,71
5/16"	3/8" NPT	281610605	5,35
3/8"	3/8" NPT	281610606	4,98
1/2"	3/8" NPT	281610608	6,26
3/8"	1/2" NPT	281610806	5,80
1/2"	1/2" NPT	281610808	5,37
5/8"	1/2" NPT	281610810	9,07
1/2"	3/4" NPT	281611208	9,42
5/8"	3/4" NPT	281611210	9,64
3/4"	3/4" NPT	281611212	12,23
1"	3/4" NPT	281611216	18,03
3/4"	1" NPT	281611612	16,64
1"	1" NPT	281611616	18,20
1"	1" 1/4 NPT	281612016	28,32
1"1/4	1"1/4 NPT	281612020	38,58
1" 1/4	1"1/2 NPT	281612420	45,24
1"1/2	1"1/2 NPT	281612424	52,85
1" 1/2	2" NPT	281613224	81,81
2"	2" NPT	281613232	89,76

CONEXIONES SERIE 43 UNA SOLA PIEZA 1SN / R1AT / 2SN / R2AT / R16 / 2SC / 3TE / R17

One piece fittings 43 Series 1SN / R1AT / 2SN / R2AT / R16 / 2SC / 3TE / R17
 Embouts pré-sertis Série 43 1SN / R1AT / 2SN / R2AT / R16 / 2SC / 3TE / R17
 Raccordi un pezzo Serie 43 1SN / R1AT / 2SN / R2AT / R16 / 2SC / 3TE / R17

Hembras giratorias rectas una sola pieza ORFS

One piece ORFS female

Femelle pré-sertie ORFS

Femmina diritta compatta ORFS



DN	ROSCA THREAD	Referencia Part n°	€
1/4"	9/16" 18h	289000904	4,25
1/4"	11/16" 16h	289001104	4,24
5/16"	11/16" 16h	289001105	5,50
3/8"	11/16" 16h	289001106	4,59
3/8"	13/16" 16h	289001306	5,16
1/2"	13/16" 16h	289001308	6,04
1/2"	1" 14h	289001608	8,49
5/8"	1" 14h	289001610	10,67
1/2"	1"3/16 12h	289001908	11,66
3/4"	1"3/16 12h	289001912	15,07
3/4"	1"7/16 12h	289002312	19,56
1"	1"7/16 12h	289002316	17,88
1"1/4	1"11/16 12h	289002720	42,94
1"1/2	2" 12h	289003224	67,89

Machos una sola pieza ORFS

One piece ORFS male

Mâle pré-serti ORFS

Maschio compatto ORFS



DN	ROSCA THREAD	Referencia Part n°	€
1/4"	9/16" 18h	289120904	4,07
1/4"	11/16" 16h	289121104	4,94
5/16"	11/16" 16h	289121105	5,15
3/8"	11/16" 16h	289121106	5,47
3/8"	13/16" 16h	289121306	6,50
1/2"	13/16" 16h	289121308	6,83
1/2"	1" 14h	289121608	7,76
5/8"	1" 14h	289121610	9,35
1/2"	1"3/16 12h	289121908	11,41
3/4"	1"3/16 12h	289121912	13,95
3/4"	1"7/16 12h	289122312	21,00
1"	1"7/16 12h	289122316	22,73
1"1/4	1"11/16 12h	289122720	42,94

Hembras giratorias 90º una sola pieza ORFS

One piece ORFS female (90º Elbow)

Coude 90º femelle pré-sertie ORFS

Femmina 90º compatta ORFS



DN	ROSCA THREAD	Referencia Part n°	€
1/4"	9/16" 18h	289070904	5,50
1/4"	11/16" 16h	289071104	7,06
5/16"	11/16" 16h	289071105	7,55
3/8"	11/16" 16h	289071106	7,01
3/8"	13/16" 16h	289071306	9,34
1/2"	13/16" 16h	289071308	8,56
1/2"	1" 14h	289071608	12,37
5/8"	1" 14h	289071610	13,73
1/2"	1"3/16 12h	289071908	17,89
3/4"	1"3/16 12h	289071912	20,26
3/4"	1"7/16 12h	289072312	29,66
1"	1"7/16 12h	289072316	32,23
1"1/4	1"11/16 12h	289072720	60,47
1"1/2	2" 12h	289073224	86,83

Hembras giratorias 45º una sola pieza ORFS

One piece ORFS female (45º Elbow)

Coude 45º femelle pré-sertie ORFS

Femmina 45º compatta ORFS



DN	ROSCA THREAD	Referencia Part n°	€
1/4"	9/16" 18h	289080904	5,36
1/2"	1" 14h	289081008	13,30
1/4"	11/16" 16h	289081104	6,59
5/16"	11/16" 16h	289081105	7,08
3/8"	11/16" 16h	289081106	7,36
3/8"	13/16" 16h	289081306	8,77
1/2"	13/16" 16h	289081308	9,10
5/8"	1" 14h	289081610	14,64
1/2"	1"3/16 12h	289081908	17,89
3/4"	1"3/16 12h	289081912	22,55
3/4"	1"7/16 12h	289082312	30,50
1"	1"7/16 12h	289082316	35,89
1"1/4	1"11/16 12h	289082720	57,91
1"1/2	2" 12h	289083224	86,83

CONEXIONES SERIE 43 UNA SOLA PIEZA 1SN / R1AT / 2SN / R2AT / R16 / 2SC / 3TE / R17

One piece fittings 43 Series 1SN / R1AT / 2SN / R2AT / R16 / 2SC / 3TE / R17
 Embouts pré-sertis Série 43 1SN / R1AT / 2SN / R2AT / R16 / 2SC / 3TE / R17
 Raccordi un pezzo Serie 43 1SN / R1AT / 2SN / R2AT / R16 / 2SC / 3TE / R17

Bridas rectas una sola pieza SAE 3000 PSI

One piece 3000 PSI SAE Straight Flange / Code 61

Bride SAE droite pré-sertie série 3000 PSI

Flangia diritta compatta SAE 3000 PSI



DN	Ø	Referencia Part nº	€
1/2"	30.2	281820808	10,63
1/2"	38.1	281821208	14,60
5/8"	38.1	281821210	17,48
3/4"	38.1	281821212	18,35
3/4"	44.5	281821612	27,95
1"	44.5	281821616	27,48
1"	50.8	281822016	35,69
1"1/4	50.8	281822020	42,18
1" 1/4	60.3	281822420	59,71
1"1/2	60.3	281822424	67,32
1" 1/2	71.4	281823224	108,36
2"	71.4	281823232	106,30

Bridas rectas una sola pieza SAE 6000 PSI

One piece 6000 PSI SAE Straight Flange / Code 62

Bride SAE droite pré-sertie série 6000 PSI

Flangia diritta compatta SAE 6000 PSI



DN	Ø	Referencia Part nº	€
1/2"	31.8	282820808	12,52
1/2"	41.3	282821208	16,18
5/8"	41.3	282821210	18,03
3/4"	41.3	282821212	21,33
3/4"	47.6	282821612	27,34
1"	47.6	282821616	30,84
1"	54	282822016	36,59
1"1/4	54	282822020	52,46
1" 1/4	63.5	282822420	65,18
1"1/2	63.5	282822424	75,53
1" 1/2	79.4	282823224	115,54
2"	79.4	282823232	117,96

Bridas 90º una sola pieza SAE 3000 PSI

One piece 3000 PSI SAE 90º Flange / Code 61

Bride SAE coude 90º pré-sertie série 3000 PSI

Flangia 90º compatta SAE 3000 PSI



DN	Ø	Referencia Part nº	€
1/2"	30.2	281830808	13,76
1/2"	38.1	281831208	17,53
5/8"	38.1	281831210	19,19
3/4"	38.1	281831212	21,46
3/4"	44.5	281831612	28,87
1"	44.5	281831616	31,18
1"	50.8	281832016	41,12
1"1/4	50.8	281832020	52,91
1" 1/4	60.3	281832420	67,93
1"1/2	60.3	281832424	76,25
1" 1/2	71.4	281833224	114,96
2"	71.4	281833232	136,13

Bridas 90º una sola pieza SAE 6000 PSI

One piece 6000 PSI SAE 90º Flange / Code 62

Bride SAE coude 90º pré-sertie série 6000 PSI

Flangia 90º compatta SAE 6000 PSI



DN	Ø	Referencia Part nº	€
1/2"	31.8	282830808	13,77
1/2"	41.3	282831208	19,66
5/8"	41.3	282831210	20,38
3/4"	41.3	282831212	22,04
3/4"	47.6	282831612	30,80
1"	47.6	282831616	33,11
1"	54	282832016	43,66
1"1/4	54	282832020	55,09
1" 1/4	63.5	282832420	71,48
1"1/2	63.5	282832424	80,12
1" 1/2	79.4	282833224	120,88

Bridas 45º una sola pieza SAE 3000 PSI

One piece 3000 PSI SAE 45º Flange / Code 61

Bride SAE coude 45º pré-sertie série 3000 PSI

Flangia 45º compatta SAE 3000 PSI



DN	Ø	Referencia Part nº	€
1/2"	30.2	281840808	12,44
1/2"	38.1	281841208	17,53
5/8"	38.1	281841210	19,19
3/4"	38.1	281841212	21,46
3/4"	44.5	281841612	29,26
1"	44.5	281841616	31,58
1"	50.8	281842016	41,68
1"1/4	50.8	281842020	52,91
1" 1/4	60.3	281842420	67,93
1"1/2	60.3	281842424	76,25
1" 1/2	71.4	281843224	121,85
2"	71.4	281843232	136,13

Bridas 45º una sola pieza SAE 6000 PSI

One piece 6000 PSI SAE 45º Flange / Code 62

Bride SAE coude 45º pré-sertie série 6000 PSI

Flangia 45º compatta SAE 6000 PSI



DN	Ø	Referencia Part nº	€
1/2"	31.8	282840808	14,63
1/2"	41.3	282841208	19,66
5/8"	41.3	282841210	20,38
3/4"	41.3	282841212	22,04
3/4"	47.6	282841612	31,23
1"	47.6	282841616	33,11
1"	54	282842016	43,66
1"1/4	54	282842020	55,09
1" 1/4	63.5	282842420	71,48
1"1/2	63.5	282842424	81,07
1" 1/2	79.4	282843224	120,88
2"	79.4	282843232	139,72

CONEXIONES SERIE 43 UNA SOLA PIEZA 1SN / R1AT / 2SN / R2AT / R16 / 2SC / 3TE / R17

One piece fittings 43 Series 1SN / R1AT / 2SN / R2AT / R16 / 2SC / 3TE / R17
 Embouts pré-sertis Série 43 1SN / R1AT / 2SN / R2AT / R16 / 2SC / 3TE / R17
 Raccordi un pezzo Serie 43 1SN / R1AT / 2SN / R2AT / R16 / 2SC / 3TE / R17

Bridas rectas una sola pieza SAE 9000 PSI

One piece 9000 PSI SAE Straight Flange

Bride SAE droite pré-sertie série 9000 PSI

Flangia diritta compatta SAE 9000 PSI



DN	∅	Referencia Part nº	€
1/2"	41.3	482821212	23,02
3/4"	47.6	482821612	33,21
1"	47.6	482821616	33,56
1"	54	482822016	41,59
1" 1/4	54	482822020	51,36
1" 1/2	63.5	482822424	84,26

Bridas 45º una sola pieza SAE 9000 PSI

One piece 9000 PSI SAE 45º Flange

Bride SAE coude 45º pré-sertie série 9000 PSI

Flangia 45º compatta SAE 9000 PSI



DN	∅	Referencia Part nº	€
1/2"	41.3	482841212	27,78
3/4"	47.6	482841612	39,87
1"	47.6	482841616	41,59
1"	54	482842016	54,50
1" 1/4	54	482842020	64,83
1" 1/2	63.5	482842424	84,26

Bridas 90º una sola pieza SAE 9000 PSI

One piece 9000 PSI SAE 90º Flange

Bride SAE coude 90º pré-sertie série 9000 PSI

Flangia 90º compatta SAE 9000 PSI



DN	∅	Referencia Part nº	€
1/2"	41.3	482831212	27,41
3/4"	47.6	482831612	39,87
1"	47.6	482831616	41,59
1"	54	482832016	54,50
1" 1/4	54	482832020	64,83
1" 1/2	63.5	482832424	84,26

FLUIDAL

CONEXIONES SERIE 43 UNA SOLA PIEZA 1SN / R1AT / 2SN / R2AT / R16 / 2SC / 3TE / R17

One piece fittings 43 Series 1SN / R1AT / 2SN / R2AT / R16 / 2SC / 3TE / R17
 Embouts pré-sertis Série 43 1SN / R1AT / 2SN / R2AT / R16 / 2SC / 3TE / R17
 Raccordi un pezzo Serie 43 1SN / R1AT / 2SN / R2AT / R16 / 2SC / 3TE / R17

Hembras giratorias rectas una sola pieza rosca Métrica cono 24° - DKO

One piece Metric female cone 24°

Femelle pré-sertie Métrique cone 24°

Femmina diritta compatta Metrica sede 24°



Machos una sola pieza rosca Métrica cono 24°

One piece Metric male cone 24°

Mâle pré-serti Métrique cone 24°

Maschio compatto Metrico sede 24°



DN	TUBO PIPE	SERIE SERIES	ROSCA THREAD	Referencia Part n°	€
1/4"	6	L	M12x1.5	28804120604	3,71
1/4"	8	L	M14x1.5	28804140804	3,56
1/4"	10	L	M16X1.5	28804161004	3,94
5/16"	10	L	M16x1.5	28804161005	4,49
3/8"	10	L	M16x1.5	28804161006	4,71
1/4"	12	L	M18X1.5	28804181204	4,34
5/16"	12	L	M18X1.5	28804181205	4,70
3/8"	12	L	M18x1.5	28804181206	4,58
3/8"	15	L	M22X1.5	28804221506	6,00
1/2"	15	L	M22x1.5	28804221508	5,68
1/2"	18	L	M26x1.5	28804261808	7,49
5/8"	18	L	M26x1.5	28804261810	7,87
3/4"	18	L	M26x1.5	NEW 28804261812	11,69
3/4"	22	L	M30x2	28804302212	12,64
1"	28	L	M36x2	28804362816	20,17
1"1/4	35	L	M45x2	28804453520	35,94
1"1/2	42	L	M52x2	28804524224	51,40
1/4"	8	S	M16x1.5	28804160804	4,23
1/4"	10	S	M18x1.5	28804181004	4,48
5/16"	12	S	M20X1.5	28804201205	4,70
3/8"	12	S	M20x1.5	28804201206	4,75
1/2"	12	S	M20X1.5	28804201208	6,16
3/8"	14	S	M22X1.5	28804221406	5,80
1/2"	16	S	M24x1.5	28804241608	6,67
5/8"	16	S	M24x1.5	NEW 28804241610	8,04
5/8"	20	S	M30x2	28804302010	8,98
3/4"	20	S	M30x2	28804302012	13,22
3/4"	25	S	M36x2	28804362512	17,72
1"	25	S	M36x2	28804362516	22,13
1"	30	S	M42x2	28804423016	24,61
1"1/4	38	S	M52x2	28804523820	42,26

DN	TUBO PIPE	SERIE SERIES	ROSCA THREAD	Referencia Part n°	€
1/4"	6	L	M12x1.5	28203120604	3,69
1/4"	8	L	M14x1.5	28203140804	3,73
1/4"	10	L	M16X1.5	28203161004	4,30
5/16"	10	L	M16x1.5	28203161005	4,23
3/8"	10	L	M16x1.5	28203161006	4,33
1/4"	12	L	M18X1.5	28203181204	4,08
5/16"	12	L	M18X1.5	28203181205	4,85
3/8"	12	L	M18x1.5	28203181206	4,17
3/8"	15	L	M22X1.5	28203221506	5,64
1/2"	15	L	M22x1.5	28203221508	5,84
1/2"	18	L	M26X1.5	28203261808	6,86
5/8"	18	L	M26x1.5	28203261810	7,41
3/4"	22	L	M30x2	28203302212	12,27
1"	28	L	M36x2	28203362816	20,08
1"1/4	35	L	M45x2	28203453520	36,70
1"1/2	42	L	M52x2	28203524224	53,30
1/4"	8	S	M16x1.5	28203160804	4,06
1/4"	10	S	M18x1.5	28203181004	4,64
5/16"	10	S	M18X1.5	28203181005	4,95
3/8"	10	S	M18X1.5	28203181006	5,09
5/16"	12	L	M20X1.5	28203201205	5,06
3/8"	12	S	M20x1.5	28203201206	5,14
3/8"	14	S	M22X1.5	28203221406	5,67
1/2"	16	S	M24x1.5	28203241608	6,44
5/8"	20	S	M30x2	28203302010	9,70
3/4"	20	S	M30x2	28203302012	13,21
3/4"	25	S	M36x2	28203362512	17,74
1"	25	S	M36x2	28203362516	20,31
1"	30	S	M42x2	28203423016	25,22
1"1/4	38	S	M52x2	28203523820	44,11

CONEXIONES SERIE 43 UNA SOLA PIEZA 1SN / R1AT / 2SN / R2AT / R16 / 2SC / 3TE / R17

One piece fittings 43 Series 1SN / R1AT / 2SN / R2AT / R16 / 2SC / 3TE / R17
 Embouts pré-sertis Série 43 1SN / R1AT / 2SN / R2AT / R16 / 2SC / 3TE / R17
 Raccordi un pezzo Serie 43 1SN / R1AT / 2SN / R2AT / R16 / 2SC / 3TE / R17

Hembras giratorias 90º una sola pieza Métricas cono 24º - DKO 90º

One piece Metric female cone 24º (90º Elbow)

Coude 90º femelle pré-sertie Métrique cono 24º

Femmina 90º compatta Metrica sede 24º



DN	TUBO PIPE	SERIE SERIES	ROSCA THREAD	Referencia Part nº	€
1/4"	6	L	M12x1.5	28305120604	4,93
1/4"	8	L	M14x1.5	28305140804	5,03
1/4"	10	L	M16x1.5	28305161004	5,21
5/16"	10	L	M16x1.5	28305161005	5,79
3/8"	10	L	M16x1.5	28305161006	6,05
5/16"	12	L	M18x1.5	28305181205	6,50
3/8"	12	L	M18x1.5	28305181206	6,02
3/8"	15	L	M22x1.5	28305221506	8,37
1/2"	15	L	M22x1.5	28305221508	7,74
5/8"	18	L	M26x1.5	28305261810	12,42
3/4"	22	L	M30x2	28305302212	17,76
1"	28	L	M36x2	28305362816	27,42
1 1/4"	35	L	M45x2	28305453520	51,27
1 1/2"	42	L	M52x2	28305524224	83,19
1/4"	8	S	M16x1.5	28305160804	5,11
1/4"	10	S	M18x1.5	28305181004	5,19
5/16"	10	S	M18x1.5	28305181005	6,92
3/8"	10	S	M18x1.5	28305181006	8,05
5/16"	12	S	M20x1.5	28305201205	6,85
3/8"	12	S	M20x1.5	28305201206	5,78
3/8"	14	S	M22x1.5	28305221406	7,73
1/2"	16	S	M24x1.5	28305241608	8,24
5/8"	20	S	M30x2	28305302010	13,86
3/4"	20	S	M30x2	28305302012	19,54
3/4"	25	S	M36x2	28305362512	23,09
1"	25	S	M36x2	28305362516	29,75
1"	30	S	M42x2	28305423016	33,90
1 1/4"	38	S	M52x2	28305523820	63,67

Hembras giratorias 45º una sola pieza Métricas cono 24º - DKO 45º

One piece Metric female cone 24º (45º Elbow)

Coude 45º femelle pré-sertie Métrique cono 24º

Femmina 45º compatta Metrica sede 24º



DN	TUBO PIPE	SERIE SERIES	ROSCA THREAD	Referencia Part nº	€
1/4"	6	L	M12x1.5	28306120604	4,96
1/4"	8	L	M14x1.5	28306140804	5,07
1/4"	10	L	M16x1.5	28306161004	5,38
5/16"	10	L	M16x1.5	28306161005	5,80
3/8"	10	L	M16x1.5	28306161006	6,11
5/16"	12	L	M18x1.5	28306181205	6,95
3/8"	12	L	M18x1.5	28306181206	5,69
1/2"	15	L	M22x1.5	28306221508	8,65
5/8"	18	L	M26x1.5	28306261810	12,76
3/4"	22	L	M30x2	28306302212	19,25
1"	28	L	M36x2	28306362816	28,18
1 1/4"	35	L	M45x2	28306453520	53,22
1 1/2"	42	L	M52x2	28306524224	79,44
1/4"	8	S	M16x1.5	28306160804	5,99
1/4"	10	S	M18x1.5	28306181004	6,77
5/16"	12	S	M20x1.5	28306201205	7,90
3/8"	12	S	M20x1.5	28306201206	7,76
3/8"	14	S	M22x1.5	28306221406	8,70
1/2"	16	S	M24x1.5	28306241608	8,92
5/8"	20	S	M30x2	28306302010	15,12
3/4"	20	S	M30x2	28306302012	19,48
3/4"	25	S	M36x2	28306362512	22,90
1"	25	S	M36x2	28306362516	28,53
1"	30	S	M42x2	28306423016	33,36
1 1/4"	38	S	M52x2	28306523820	65,65

Orientable una sola pieza Métrico Recto

One piece Banjo metric

Banjo droit pré-serti Métrique

Raccordo ad occhio Metrico compatto



DN	Ø	Referencia Part nº	€
1/4"	M10x1	281161004	4,61
1/4"	M12x1.5	281161204	4,70
1/4"	M14x1.5	281161404	5,15
5/16"	M14x1.5	281161405	6,11
3/8"	M14x1.5	281161406	5,79
5/16"	M16x1.5	281161605	5,84
3/8"	M16x1.5	281161606	5,70
3/8"	M18x1.5	281161806	6,84
1/2"	M18x1.5	281161808	7,18
1/2"	M22x1.5	281162208	9,56
5/8"	M22x1.5	281162210	9,91
3/4"	M30x2	281163012	17,94

CONEXIONES SERIE 43 UNA SOLA PIEZA 1SN / R1AT / 2SN / R2AT / R16 / 2SC / 3TE / R17

One piece fittings 43 Series 1SN / R1AT / 2SN / R2AT / R16 / 2SC / 3TE / R17
 Embouts pré-sertis Série 43 1SN / R1AT / 2SN / R2AT / R16 / 2SC / 3TE / R17
 Raccordi un pezzo Serie 43 1SN / R1AT / 2SN / R2AT / R16 / 2SC / 3TE / R17

Hembras giratorias una sola pieza Métricas cono 24° / 60°

One piece Female metric swivel 24° / 60° cone

Femelle tournante pré-sertie Métrique cône 24° - 60°

Femmina Metrica Girevole Multiseal compatta 24° / 60°



DN	TUBO PIPE	ROSCA THREAD	Referencia Part n°	€
1/4"	8L	M14X1.5	284049511	3,88
1/4"	10L	M16X1.5	284049520	4,28
5/16"	10L	M16X1.5	284049523	4,71
3/8"	10L	M16X1.5	284049524	5,25
5/16"	12L	M18X1.5	284049525	5,12
3/8"	12L	M18X1.5	284049535	5,12
3/8"	15L	M22X1.5	284049552	6,73
1/2"	15L	M22X1.5	284049555	7,27
5/8"	18L	M26X1.5	284049571	9,96

Hembras giratorias 90° una sola pieza Métricas cono 24° / 60°

One piece Female metric swivel 24° / 60° cone (90° Elbow)

Femelle tournante coude 90° pré-sertie Métrique cône 24° - 60°

Femmina Metrica Girevole a 90° Multiseal compatta 24° / 60°



DN	TUBO PIPE	ROSCA THREAD	Referencia Part n°	€
1/4"	8L	M14X1.5	284059511	4,41
1/4"	10L	M16X1.5	284059520	4,79
5/16"	10L	M16X1.5	284059523	5,11
3/8"	10L	M16X1.5	284059524	6,01
5/16"	12L	M18X1.5	284059525	5,54
3/8"	12L	M18X1.5	284059535	5,54
3/8"	15L	M22X1.5	284059552	7,73
1/2"	15L	M22X1.5	284059555	8,43
5/8"	18L	M26X1.5	284059571	12,23

Hembras giratorias 45° una sola pieza Métricas cono 24° / 60°

One piece Female metric swivel 24° / 60° cone (45° Elbow)

Femelle tournante coude 45° pré-sertie Métrique cône 24° - 60°

Femmina Metrica Girevole a 45° Multiseal compatta 24° / 60°



DN	TUBO PIPE	ROSCA THREAD	Referencia Part n°	€
1/4"	8L	M14X1.5	284069511	5,78
5/16"	10L	M16X1.5	284069523	6,52
3/8"	10L	M16X1.5	284069524	7,26
5/16"	12L	M18X1.5	284069525	7,26
3/8"	12L	M18X1.5	284069535	5,76
1/2"	15L	M22X1.5	284069555	9,70
5/8"	18L	M26X1.5	284069571	14,39

Espiga lisa recta una sola pieza Métrica

One piece Metric standpipe

Embout lisse droit pré-serti Métrique

Estremità tubolare diritta Metrica compatta



DN	TUBO PIPE	Referencia Part n°	€
1/4"	6	281580604	3,45
1/4"	8	281580804	3,12
5/16"	8	281580805	6,77
1/4"	10	281581004	3,10
5/16"	10	281581005	4,27
3/8"	10	281581006	3,89
1/4"	12	281581204	3,97
5/16"	12	281581205	4,26
3/8"	12	281581206	3,98
1/2"	12	281581208	8,72
3/8"	14	281581406	4,96
1/2"	14	281581408	5,96
3/8"	15	281581506	4,50
1/2"	15	281581508	5,00
1/2"	16	281581608	5,76
1/2"	18	281581808	5,01
5/8"	18	281581810	7,99
3/4"	20	281582012	12,07
3/4"	22	281582212	11,40
1"	25	281582516	18,56
1"	28	281582816	16,81
1"	30	281583016	17,80
1"1/4	35	281583520	34,88
1"1/2	42	281584224	43,11

Hembras giratorias rectas una sola pieza Komatsu cono 60°

One piece Komatsu swivel female 60° cone

Femelle tournante droite Komatsu pré-serti Métrique (cône 60°)

Femmina Komatsu sede 60° compatta



DN	ROSCA THREAD	Referencia Part n°	€
1/4"	M14X1.5	288049625	6,52
3/8"	M18X1.5	288049635	6,57
1/2"	M22X1.5	288049655	10,54
5/8"	M24X1.5	288049665	13,79
3/4"	M30X1.5	288049684	18,13
1"	M33X1.5	288049685	24,82

Espigas de prensar dobles una sola pieza

One piece Double crimp standpipe

Embout double jonction pré-serti

Giunzione tubo-tubo compatta



DN	Referencia Part n°	€
1/4"	283000404	4,07
5/16"	283000505	5,06
3/8"	283000606	4,88
1/2"	283000808	5,72
3/4"	283001212	16,51
1"	283001616	24,34

CONEXIONES SERIE 43 UNA SOLA PIEZA 1SN / R1AT / 2SN / R2AT / R16 / 2SC / 3TE / R17

One piece fittings 43 Series 1SN / R1AT / 2SN / R2AT / R16 / 2SC / 3TE / R17
 Embouts pré-sertis Série 43 1SN / R1AT / 2SN / R2AT / R16 / 2SC / 3TE / R17
 Raccordi un pezzo Serie 43 1SN / R1AT / 2SN / R2AT / R16 / 2SC / 3TE / R17

Hembras giratorias rectas una sola pieza rosca BSP cono 60º

One piece BSP female 60º cone

Femelle pré-sertie BSP cone 60º

Femmina diritta compatta BSP sede 60º



DN	ROSCA THREAD	Referencia Part nº	€
1/4"	1/8" BSP	281000204	3,84
3/16"	1/4" BSP	281000403	3,92
1/4"	1/4" BSP	281000404	3,50
5/16"	1/4" BSP	281000405	4,45
3/8"	1/4" BSP	281000406	4,61
1/4"	3/8" BSP	281000604	4,29
5/16"	3/8" BSP	281000605	4,60
3/8"	3/8" BSP	281000606	4,46
1/2"	3/8" BSP	281000608	5,34
1/4"	1/2" BSP	281000804	4,91
3/8"	1/2" BSP	281000806	5,24
1/2"	1/2" BSP	281000808	5,58
5/8"	1/2" BSP	281000810	7,60
1/2"	5/8" BSP	281001008	7,08
5/8"	3/4" BSP	NEW 281001210	8,56
5/8"	5/8" BSP	281001010	7,80
1/2"	3/4" BSP	281001208	7,21
3/4"	3/4" BSP	281001212	11,37
3/4"	1" BSP	281001612	15,30
1"	1" BSP	281001616	16,77

Hembras giratorias rectas una sola pieza rosca BSP cono 60º doble hexagonal

One piece double hexagonal BSP female 60º cone

Femelle pré-sertie BSP cone 60º double hexagonal

Femmina diritta compatta BSP sede 60º doppio esagono

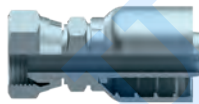

DN	ROSCA THREAD	Referencia Part nº	€
1/4"	1/4" BSP	284000404	4,87
5/16"	3/8" BSP	284000605	5,76
3/8"	3/8" BSP	284000606	6,01
1/2"	1/2" BSP	284000808	7,18
3/4"	3/4" BSP	284001212	15,84
1"	1" BSP	284001616	20,65
1"1/4	1"1/4 BSP	284002020	44,78
1"1/2	1"1/2 BSP	284002424	65,78
2"	2" BSP	284003232	111,72

Hembras giratorias 90º una sola pieza BSP cono 60º (compactas)

One piece BSP Swivel female 60º cone compact (90º Elbow)

Coude 90º femelle tournante pré-serti compact gaz cyl BSP 60º

Femmina a 90º compatta BSP sede 60º (compatta)



DN	ROSCA THREAD	Referencia Part nº	€
1/4"	1/4" BSP	281270404	6,40
3/8"	3/8" BSP	281270606	7,99
1/2"	1/2" BSP	281270808	10,00
3/4"	3/4" BSP	281271212	18,48

Hembras giratorias 90º una sola pieza rosca BSP cono 60º

One piece BSP female cone 60º (90º Elbow)

Coude 90º femelle pré-sertie BSP cone 60º

Femmina 90º compatta BSP sede 60º



DN	ROSCA THREAD	Referencia Part nº	€
1/4"	1/8" BSP	281070204	4,60
1/4"	1/4" BSP	281070404	4,58
1/4"	3/8" BSP	281070604	5,53
5/16"	3/8" BSP	281070605	6,24
3/8"	3/8" BSP	281070606	5,99
1/4"	1/2" BSP	281070804	7,51
3/8"	1/2" BSP	281070806	6,91
1/2"	1/2" BSP	281070808	7,48
1/2"	5/8" BSP	281071008	11,65
5/8"	5/8" BSP	281071010	12,08
1/2"	3/4" BSP	281071208	11,59
5/8"	3/4" BSP	281071210	13,27
3/4"	3/4" BSP	281071212	15,42
3/4"	1" BSP	281071612	22,50
1"	1" BSP	281071616	24,82

Hembras giratorias 45º una sola pieza rosca BSP cono 60º

One piece BSP female 60º cone (45º Elbow)

Coude 45º femelle pré-sertie BSP cone 60º

Femmina 45º compatta BSP sede 60º



DN	ROSCA THREAD	Referencia Part nº	€
1/4"	1/8" BSP	281080204	4,31
1/4"	1/4" BSP	281080404	4,62
1/4"	3/8" BSP	281080604	5,24
5/16"	3/8" BSP	281080605	6,45
3/8"	3/8" BSP	281080606	6,18
3/8"	1/2" BSP	281080806	7,65
1/2"	1/2" BSP	281080808	7,98
1/2"	5/8" BSP	281081008	10,98
5/8"	5/8" BSP	281081010	12,27
5/8"	3/4" BSP	281081210	13,97
3/4"	3/4" BSP	281081212	17,24
3/4"	1" BSP	281081612	24,44
1"	1" BSP	281081616	24,94

CONEXIONES SERIE 43 UNA SOLA PIEZA 1SN / R1AT / 2SN / R2AT / R16 / 2SC / 3TE / R17

One piece fittings 43 Series 1SN / R1AT / 2SN / R2AT / R16 / 2SC / 3TE / R17
 Embouts pré-sertis Série 43 1SN / R1AT / 2SN / R2AT / R16 / 2SC / 3TE / R17
 Raccordi un pezzo Serie 43 1SN / R1AT / 2SN / R2AT / R16 / 2SC / 3TE / R17

Hembras giratorias rectas una sola pieza rosca BSP cono 60° con junta tórica

One piece BSP female 60° cone +o'ring

Femelle pré-sertie BSP cono 60°+ o'ring

Femmina diritta compatta BSP sede 60°+o'ring



DN	ROSCA THREAD	Referencia Part n°	€
1/4"	1/4" BSP	281100404	3,91
3/8"	3/8" BSP	281100606	5,03
1/2"	1/2" BSP	281100808	6,07
5/8"	5/8" BSP	281101010	9,32
5/8"	3/4" BSP	281101210	9,71
3/4"	3/4" BSP	281101212	11,69
1"	1" BSP	281101616	19,50
1"	1"1/4 BSP	281102016	27,74
1" 1/4	1"1/4 BSP	281102020	38,99
1" 1/4	1" 1/2 BSP	281102420	45,81
1" 1/2	1" 1/2 BSP	281102424	52,70
1" 1/2	2" BSP	281103224	74,02
2"	2" BSP	281103232	91,19

Hembras giratorias 90° una sola pieza rosca BSP cono 60° con junta tórica

One piece BSP female cone 60° (90° Elbow) +o'ring

Coude 90° femelle pré-sertie BSP cono 60° +o'ring

Femmina 90° compatta BSP sede 60° +o'ring



DN	ROSCA THREAD	Referencia Part n°	€
1/4"	1/4" BSP	281170404	5,93
3/8"	3/8" BSP	281170606	7,41
1/2"	1/2" BSP	281170808	9,76
5/8"	5/8" BSP	281171010	13,75
3/4"	3/4" BSP	281171212	18,42
1"	1" BSP	281171616	28,49
1"	1" 1/4 BSP	281172016	40,66
1" 1/4	1"1/4 BSP	281172020	55,26
1" 1/4	1" 1/2 BSP	281172420	56,88
1" 1/2	1"1/2 BSP	281172424	68,74
2"	2" BSP	281173232	147,92

Hembras giratorias 45° una sola pieza rosca BSP cono 60° con junta tórica

One piece BSP female 60° cone (45° Elbow) +o'ring

Coude 45° femelle pré-sertie BSP cono 60° +o'ring

Femmina 45° compatta BSP sede 60° +o'ring



DN	ROSCA THREAD	Referencia Part n°	€
3/8"	3/8" BSP	281180606	6,64
1/2"	1/2" BSP	281180808	8,10
5/8"	5/8" BSP	281181010	12,55
3/4"	3/4" BSP	281181212	22,82
1"	1" BSP	281181616	26,21
1" 1/4	1"1/4 BSP	281182020	44,82
1" 1/2	1"1/2 BSP	281182424	62,10
2"	2" BSP	281183232	100,29

Hembras giratorias rectas una sola pieza BSP asiento plano

One piece BSP Swivel female flat seat

Femelle pré-sertie tournante fond plat BSP

Femmina diritta compatta BSP sede piana



DN	ROSCA THREAD	Referencia Part n°	€
1/4"	1/4" BSP	282000404	3,98
5/16"	3/8" BSP	282000605	5,23
3/8"	3/8" BSP	282000606	5,28
3/8"	1/2" BSP	282000806	5,35
1/2"	1/2" BSP	282000808	5,71
1/2"	3/4" BSP	282001208	8,46
3/4"	3/4" BSP	282001212	12,83
1"	1" BSP	282001616	18,43
1" 1/4	1"1/4 BSP	282002020	40,43
1" 1/2	1" 1/2 BSP	282002424	55,34

Hembras giratorias 90° una sola pieza BSP asiento plano

One piece BSP Swivel female flat seat (90° Elbow)

Embout pré-serti coude 90° femelle tournante fond plat BSP

Femmina a 90° compatta BSP sede 60° sede piana



DN	ROSCA THREAD	Referencia Part n°	€
1/4"	1/4" BSP	282070404	5,32
3/8"	3/8" BSP	282070606	7,05
1/2"	1/2" BSP	282070808	7,46
3/4"	3/4" BSP	282071212	19,10
1"	1" BSP	282071616	30,32

Macho rosca cilíndrica BSP una sola pieza asiento plano

One piece BSP Male flat seat

Mâle pré-serti fixe gaz cyl fond plat

Maschio BSP compatto cilindrico sede piana



DN	ROSCA THREAD	Referencia Part n°	€
1/4"	1/4" BSP	282120404	4,88
3/8"	3/8" BSP	282120606	6,31
3/8"	1/2" BSP	282120806	7,88
1/2"	1/2" BSP	282120808	8,08
3/4"	3/4" BSP	282121212	14,76
1"	1" BSP	282121616	23,17

CONEXIONES SERIE 43 UNA SOLA PIEZA 1SN / R1AT / 2SN / R2AT / R16 / 2SC / 3TE / R17

One piece fittings 43 Series 1SN / R1AT / 2SN / R2AT / R16 / 2SC / 3TE / R17

Embout pré-serti Série 43 1SN / R1AT / 2SN / R2AT / R16 / 2SC / 3TE / R17

Raccordi un pezzo Serie 43 1SN / R1AT / 2SN / R2AT / R16 / 2SC / 3TE / R17

Machos una sola pieza rosca cilíndrica BSP cono 60º

One piece BSP male 60º cone

Mâle pré-serti BSP cono 60º

Maschio compatto cilindrico BSP sede 60º



DN	ROSCA THREAD	Referencia Part nº	€
1/4"	1/8" BSP	281120204	3,71
1/4"	1/4" BSP	281120404	3,62
3/8"	1/4" BSP	281120406	5,20
1/4"	3/8" BSP	281120604	4,41
5/16"	3/8" BSP	281120605	4,80
3/8"	3/8" BSP	281120606	4,60
1/2"	3/8" BSP	281120608	5,78
1/4"	1/2" BSP	281120804	5,86
3/8"	1/2" BSP	281120806	5,80
1/2"	1/2" BSP	281120808	5,75
1/2"	5/8" BSP	281121008	9,00
5/8"	5/8" BSP	281121010	9,25
1/2"	3/4" BSP	281121208	8,86
5/8"	3/4" BSP	281121210	10,27
3/4"	3/4" BSP	281121212	11,65
3/4"	1" BSP	281121612	18,58
1"	1" BSP	281121616	17,08
1"	1"1/4 BSP	281122016	31,42
1"1/4"	1"1/4 BSP	281122020	41,49
1"1/2"	1"1/2 BSP	281122424	50,47
2"	2" BSP	281123232	94,43

Orientable una sola pieza BSP

One piece Banjo BSP

Embout pré-serti Banjo droit gaz

Raccordo ad occhio compatto BSP



DN	ROSCA THREAD	Referencia Part nº	€
1/4"	1/4" BSP	281110404	4,39
5/16"	1/4" BSP	281110405	5,47
3/8"	1/4" BSP	281110406	5,46
1/4"	3/8" BSP	281110604	5,64
5/16"	3/8" BSP	281110605	6,45
3/8"	3/8" BSP	281110606	5,95
1/2"	3/8" BSP	281110608	6,36
3/8"	1/2" BSP	281110806	7,68
1/2"	1/2" BSP	281110808	8,06
5/8"	5/8" BSP	281111010	16,57
1/2"	3/4" BSP	281111208	14,56
5/8"	3/4" BSP	281111210	19,12
3/4"	3/4" BSP	281111212	19,63
1"	1" BSP	281111616	41,47

Macho rosca cónica una sola pieza BSPT

One piece BSPT Male tapered

Mâle pré-serti fixe gaz conique BSPT

Maschio BSPT compatto conico

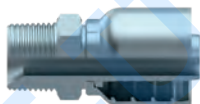

DN	ROSCA THREAD	Referencia Part nº	€
1/4"	1/8" BSPT	281140204	3,29
1/4"	1/4" BSPT	281140404	3,29
1/4"	3/8" BSPT	281140604	4,12
5/16"	3/8" BSPT	281140605	4,33
3/8"	3/8" BSPT	281140606	4,45
3/8"	1/2" BSPT	281140806	5,04
1/2"	1/2" BSPT	281140808	5,57
5/8"	3/4" BSPT	281141210	9,87
3/4"	3/4" BSPT	281141212	12,63
3/4"	1" BSPT	281141612	16,66
1"	1" BSPT	281141616	19,54
1"	1"1/4 BSPT	281142016	26,55
1"1/4"	1"1/4 BSPT	281142020	39,86
1"1/2"	1"1/2 BSPT	281142424	47,07
2"	2" BSPT	281143232	95,04

CONEXIONES SERIE BW UNA SOLA PIEZA R12 / 4SP / 4SH NO PELAR

One piece fittings BW series R12 / 4SP / 4SH NO SKIVE
 Embouts pré-sertis Série BW R12 / 4SP / 4SH sans dénuder
 Raccordi BW - 1 pezzo R12 / 4SP / 4SH senza spellatura

Macho JIC 37º

JIC 37º male

Mâle JIC 37º

Maschio JIC 37º



DN	ROSCA THREAD	Referencia Part nº	€
3/4"	1"1/16 12h UNF	681401712	14,51

Hembras giratorias rectas JIC 37º doble hexagono

JIC 37º swivel female

Femelle JIC 37º

Femmina diritta JIC 37º



DN	ROSCA THREAD	Referencia Part nº	€
3/4"	1"1/16 12h UNF	682421712	16,22
1"	1"5/16 12h UNF	682422116	20,88

Hembras giratorias 90º JIC 37º

JIC 37º swivel female (90º Elbow)

Coude 90º femelle JIC 37º

Femmina gir. 90º JIC 37º



DN	ROSCA THREAD	Referencia Part nº	€
3/4"	1"1/16 12h UNF	681381712	17,89

Hembras giratorias 45º JIC 37º

JIC 37º swivel female (45º Elbow)

Coude 45º femelle JIC 37º

Femmina gir. 45º JIC 37º



DN	ROSCA THREAD	Referencia Part nº	€
3/4"	1"1/16 12h UNF	681391712	17,93

Hembra giratoria 90º ORFS asiento plano

ORFS Swivel female (90º Elbow)

Coude 90º femelle ORFS

Femmina 90º ORFS



DN	ROSCA THREAD	Referencia Part nº	€
3/4"	1"3/16 12h UNF	689071212	21,46

Hembra giratoria 45º ORFS asiento plano

ORFS Swivel female (45º Elbow)

Coude 45º femelle ORFS

Femmina 45º ORFS



TUBO	ROSCA THREAD	Referencia Part nº	€
3/4"	1"3/16 12h UNF	689081212	23,75
1"	1"7/16 12h UNF	689081616	36,75

CONEXIONES SERIE BW UNA SOLA PIEZA R12 / 4SP / 4SH NO PELAR

One piece fittings BW series R12 / 4SP / 4SH NO SKIVE
 Embouts pré-sertis Série BW R12 / 4SP / 4SH sans dénuder
 Raccordi BW - 1 pezzo R12 / 4SP / 4SH senza spellatura

Brida recta SAE 3000 PSI

One piece 3000 PSI SAE Straight Flange/ Code 61

Bride SAE droite série 3000 PSI

Flangia diritta SAE 3000



DN	∅	Referencia Part n°	€
3/4"	38.1	681821212	19,55

Brida a 90° SAE 3000 PSI

One piece 3000 PSI SAE Flange (90° Elbow)/ Code 61

Bride SAE coude 90° série 3000 PSI

Flangia 90° SAE 3000



DN	∅	Referencia Part n°	€
3/4"	38.1	681831212	22,66
1"1/4	50.8	681832020	42,04

Brida a 45° SAE 3000 PSI

One piece 3000 PSI SAE Flange (45° Elbow)/ Code 61

Bride SAE coude 45° série 3000 PSI

Flangia 45° SAE 3000



DN	∅	Referencia Part n°	€
3/4"	38.1	681841212	22,66
1"	44.5	681841616	32,44
1"1/4	50.8	681842020	52,45

Brida recta SAE 6000 PSI

One piece 6000 PSI SAE Straight Flange/ Code 62

Bride SAE droite série 6000 PSI

Flangia diritta SAE 6000



DN	∅	Referencia Part n°	€
3/4"	41,3	682821212	22,53
1"	47,6	682821616	31,70

Brida a 90° SAE 6000 PSI

One piece 6000 PSI SAE Flange (90° Elbow)/ Code 62

Bride SAE coude 90° série 6000 PSI

Flangia 90° SAE 6000



DN	∅	Referencia Part n°	€
3/4"	41,3	682831212	23,24
1"	47,6	682831616	33,97

Brida a 45° SAE 6000 PSI

One piece 6000 PSI SAE Flange (45° Elbow)/ Code 62

Bride SAE coude 45° série 6000 PSI

Flangia 45° SAE 6000



DN	∅	Referencia Part n°	€
3/4"	41,3	682841212	23,24
1"	47,6	682841616	33,97

CONEXIONES SERIE BW UNA SOLA PIEZA R12 / 4SP / 4SH NO PELAR

One piece fittings BW series R12 / 4SP / 4SH NO SKIVE
 Embouts pré-sertis Série BW R12 / 4SP / 4SH sans dénuder
 Raccordi BW - 1 pezzo R12 / 4SP / 4SH senza spellatura

Hembras giratorias 90º Métricas cono 24º con junta tórica

Metric swivel female 24º seat with o´ring (90º Elbow)

Coûde 90º femelle Métrique 24º avec o´ring

Femmina Metrica 90º sede 24º con o´ring



ROSCA THREAD	Referencia Part nº	€
3/4"	M36X2 68205362512	24,29
1"1/4	M52X2 68205523820	63,22

Hembras giratorias 45º Métricas cono 24º con junta tórica

Metric swivel female 24º seat with o´ring (45º Elbow)

Coûde 45º femelle Métrique 24º avec o´ring

Femmina Metrica 45º sede 24º con o´ring



DN	ROSCA THREAD	Referencia Part nº	€
3/4"	M36X2	68206362512	24,10

Machos fijos Métricos cono 24º

Metric male stud 24º cone

Mâle Métrique cono 24º

Maschio Metrico sede 24º



DN	ROSCA THREAD	Referencia Part nº	€
3/4"	M36X2	68203362512	18,94
1"	M42X2	68203423016	26,08

Hembras giratorias rectas BSP cono 60º

BSP Swivel female 60º cone

Femelle tournante gaz cyl BSP 60º

Femmina diritta BSP sede 60º



DN	ROSCA THREAD	Referencia Part nº	€
3/4"	3/4" BSP	681101212	12,89

Hembras giratorias 90º BSP cono 60º

BSP Swivel female 60º cone (90º Elbow)

Coûde 90º femelle tournante gaz cyl BSP 60º

Femmina a 90º BSP sede 60º



DN	ROSCA THREAD	Referencia Part nº	€
3/4"	3/4" BSP	681071212	16,62
1"	1" BSP	681071616	25,68
1"1/4	1"1/4 BSP	681072020	54,81

Hembras giratorias 45º BSP cono 60º

BSP Swivel female 60º cone (45º Elbow)

Hembras giratorias 45º BSP cono 60º

Femmina a 45º BSP sede 60º



DN	ROSCA THREAD	Referencia Part nº	€
3/4"	3/4" BSP	681081212	18,44
1"1/4	1"1/4 BSP	681082020	54,81

Macho BSP cono 60º

BSP Male 60º

Mâle gaz cylindrique BSP 60º

Maschio BSP cilindrico sede 60º



DN	ROSCA THREAD	Referencia Part nº	€
1"	1" BSP	681121616	17,94
1"1/4	1"1/4 BSP	681122020	41,04

CONEXIONES UNA SOLA PIEZA SERIE BWS 3SP/4SP/R12/4SH NO PELAR

One piece fittings BWS SERIES 3SP/4SP/R12/4SH NO SKIVE

Embouts pré-sertis BWS 3SP/4SP/R12/4SH Sans dénuder

Raccordi compatti serie BWS R12/4SP/4SH Serie BW senza spellatura

R13 & R15 - Ø 3/4" - 1"

Machos una sola pieza rosca JIC 37º

NEW

One piece JIC 37º male

Mâle pré-serti JIC 37º

Maschio compatto JIC sede 37º



DN	ROSCA THREAD	Referencia Part nº	€
3/8"	9/16" 18h UNF	581400906	4,41
1/2"	3/4" 16h UNF	581401208	5,62
5/8"	7/8" 14h UNF	581401410	8,75
3/4"	1"1/16 12h UN	581401712	14,51
1"	1"5/16 12h UN	581402116	21,29
1"1/4	1"5/8 12h UN	581402620	39,72
1"1/2	1"7/8 12 UN	581403024	63,93
2"	2"1/2 12h UN	581404032	109,42

Hembras giratorias 45º una sola pieza JIC 37º

NEW

One piece JIC 37º Swivel female (45º Elbow)

Coude 45º femelle pré-sertie JIC 37º

Femmina 45º compatta JIC 37º



DN	ROSCA THREAD	Referencia Part nº	€
3/8"	9/16" 18h UNF	581390906	6,71
1/2"	3/4" 16h UNF	581391208	9,41
5/8"	7/8" 14h UNF	581391410	12,67
3/4"	1"1/16 12h UN	581391712	17,93
1"	1"5/16 12h UN	581392116	26,47
1"1/4	1"5/8 12h UN	581392620	55,33
1"1/2	1"7/8 12 UN	581393024	89,78
2"	2"1/2 12h UN	581394032	155,64

Hembras giratorias rectas una sola pieza JIC 37º

NEW

One piece JIC 37º Swivel female

Femelle pré-sertie JIC 37º

Femmina diritta compatta JIC 37º



DN	ROSCA THREAD	Referencia Part nº	€
3/8"	9/16" 18h UNF	581420906	4,66
1/2"	3/4" 16h UNF	581421208	6,50
5/8"	7/8" 14h UNF	581421410	9,07
3/4"	1"1/16 12h UN	581421712	12,68
1"	1"5/16 12h UN	581422116	20,59
1"1/4	1"5/8 12h UN	581422620	34,93
1"1/2	1"7/8 12 UN	581423024	59,01
2"	2"1/2 12h UN	581424032	99,38

Hembras giratorias rectas una sola pieza JIC 37º doble hexagonal

NEW

One piece double hexagonal JIC 37º Swivel female

Femelle pré-sertie JIC 37º double hexagonal

Femmina diritta JIC 37º doppio esagono



DN	ROSCA THREAD	Referencia Part nº	€
3/8"	9/16" 18h UNF	582420906	5,99
1/2"	3/4" 16h UNF	582421208	7,74
5/8"	7/8" 14h UNF	582421410	10,22
3/4"	1"1/16 12h UN	582421712	16,22
1"	1"5/16 12h UN	582422116	20,88
1"1/4	1"5/8 12h UN	582422620	43,01
1"1/2	1"7/8 12 UN	582423024	72,25
2"	2"1/2 12h UN	582424032	123,90

Hembras giratorias 90º una sola pieza JIC 37º

NEW

One piece JIC 37º Swivel female (90º Elbow)

Coude 90º femelle pré-sertie JIC 37º

Femmina 90º compatta JIC 37º



DN	ROSCA THREAD	Referencia Part nº	€
3/8"	9/16" 18h UNF	581380906	7,15
1/2"	3/4" 16h UNF	581381208	7,50
5/8"	7/8" 14h UNF	581381410	13,61
3/4"	1"1/16 12h UN	581381712	17,89
1"	1"5/16 12h UN	581382116	25,93
1"1/4	1"5/8 12h UN	581382620	51,20
1"1/2	1"7/8 12 UN	581383024	81,84
2"	2"1/2 12h UN	581384032	152,08

CONEXIONES UNA SOLA PIEZA SERIE BWS 3SP/4SP/R12/4SH NO PELAR

One piece fittings BWS SERIES 3SP/4SP/R12/4SH NO SKIVE

Embouts pré-sertis BWS 3SP/4SP/R12/4SH Sans dénuder

Raccordi compatti serie BWS R12/4SP/4SH Serie BW senza spellatura

Hembras giratorias rectas una sola pieza ORFS



One piece ORFS Swivel female

Femelle pré-sertie ORFS

Femmina diritta compatta ORFS



DN	ROSCA THREAD	Referencia Part n°	€
3/8"	11/16" 16h UNF	589000606	4,83
1/2"	13/16" 16h UNF	589000808	6,62
5/8"	1" 14h UNF	589001010	11,44
3/4"	1"3/16 12h UNF	589001212	16,27
1"	1"7/16 12h UNF	589001616	18,74
1"1/4	1"11/16 12h UNF	589002020	42,49
1"1/2	2" 12h UNF	589002424	75,71

Hembras giratorias 90º una sola pieza ORFS



One piece ORFS Swivel female (90° Elbow)

Coude 90° femelle pré-sertie ORFS

Femmina 90° compatta ORFS



DN	ROSCA THREAD	Referencia Part n°	€
3/8"	11/16" 16h UNF	589070606	7,25
1/2"	13/16" 16h UNF	589070808	9,15
5/8"	1" 14h UNF	589071010	14,49
3/4"	1"3/16 12h UNF	589071212	21,46
1"	1"7/16 12h UNF	589071616	33,09
1"1/4	1"11/16 12h UNF	589072020	60,02
1"1/2	2" 12h UNF	589072424	94,65

Hembras giratorias 45º una sola pieza ORFS



One piece ORFS Swivel female (45° Elbow)

Coude 45° femelle pré-sertie ORFS

Femmina 45° compatta ORFS



DN	ROSCA THREAD	Referencia Part n°	€
3/8"	11/16" 16h UNF	589080606	7,61
1/2"	13/16" 16h UNF	589080808	9,69
5/8"	1" 14h UNF	589081010	15,41
3/4"	1"3/16 12h UNF	589081212	23,75
1"	1"7/16 12h UNF	589081616	36,75
1"1/4	1"11/16 12h UNF	589082020	57,45
1"1/2	2" 12h UNF	589082424	94,65

Machos una sola pieza ORFS



One piece ORFS male

Mâle pré-serti ORFS

Maschio compatto ORFS



DN	ROSCA THREAD	Referencia Part n°	€
3/8"	11/16" 16h UN	589120606	5,71
1/2"	13/16" 16h UN	589120808	7,42
5/8"	1" 14h UN	589121010	10,11
3/4"	1"3/16 12h UN	589121212	15,15
1"	1"7/16 12h UN	589121616	23,59
1"1/4	1"11/16 12h UN	589122020	42,49

Hembras giratorias rectas una sola pieza rosca NPSM cono 60º



One piece NPSM Swivel female 60° cone

Femelle pré-sertie NPSM cone 60°

Femmina diritta compatta NPSM sede 60°



DN	ROSCA THREAD	Referencia Part n°	€
3/8"	3/8" NPT	582610606	5,59
1/2"	1/2" NPT	582610808	7,21
3/4"	3/4" NPT	582611212	13,95
1"	1" NPT	582611616	19,30

Machos una sola pieza rosca cónica NPT



One piece NPT male pipe straight

Mâle pré-serti NPT

Maschio compatto conico NPT



DN	ROSCA THREAD	Referencia Part n°	€
3/8"	3/8" NPT	581610606	5,23
1/2"	1/2" NPT	581610808	5,96
3/4"	3/4" NPT	581611212	13,43
1"	1" NPT	581611616	19,06
1"1/4	1"1/4 NPT	581612020	38,12
1"1/2	1"1/2 NPT	581612424	60,68
2"	2" NPT	581613232	100,78

CONEXIONES UNA SOLA PIEZA SERIE BWS 3SP/4SP/R12/4SH NO PELAR

One piece fittings BWS SERIES 3SP/4SP/R12/4SH NO SKIVE

Embouts pré-sertis BWS 3SP/4SP/R12/4SH Sans dénuder

Raccordi compatti serie BWS R12/4SP/4SH Serie BW senza spellatura

Bridas rectas una sola pieza SAE 3000 PSI



One piece 3000 PSI SAE Straight Flange / Code 61

Bride SAE droite pré-sertie série 3000 PSI

Flangia diritta compatta SAE 3000 PSI



DN	∅	Referencia Part n°	€
1/2"	30.2	581820808	11,22
3/4"	38.1	581821212	19,55
1"	44.5	581821616	28,34
1"1/4	50.8	581822020	41,73
1"1/2	60.3	581822424	75,14
2"	71.4	581823232	117,31

Bridas rectas una sola pieza SAE 6000 PSI



One piece 6000 PSI SAE Straight Flange / Code 62

Bride SAE droite pré-sertie série 6000 PSI

Flangia diritta compatta SAE 6000 PSI



DN	∅	Referencia Part n°	€
1/2"	31.8	582820808	13,11
3/4"	41.3	582821212	22,53
1"	47.6	582821616	31,70
1"1/4	54.0	582822020	52,01
1"1/2	63.5	582822424	83,36
2"	79.4	582823232	128,98

Bridas 90º una sola pieza SAE 3000 PSI



One piece 3000 PSI SAE Flange (90º Elbow)/ Code 61

Bride SAE coude 90º pré-sertie série 3000 PSI

Flangia 90º compatta SAE 3000 PSI



DN	∅	Referencia Part n°	€
1/2"	30.2	581830808	14,35
3/4"	38.1	581831212	22,66
1"	44.5	581831616	32,04
1"1/4	50.8	581832020	42,04
1"1/2	60.3	581832424	84,07
2"	71.4	581833232	147,14

Bridas 90º una sola pieza SAE 6000 PSI



One piece 6000 PSI SAE Flange (90º Elbow)/ Code 62

Bride SAE coude 90º pré-sertie série 6000 PSI

Flangia 90º compatta SAE 6000 PSI



DN	∅	Referencia Part n°	€
1/2"	31.8	582830808	14,36
3/4"	41.3	582831212	23,24
1"	47.6	582831616	33,97
1"1/4	54.0	582832020	54,64
1"1/2	63.5	582832424	87,95

Bridas 45º una sola pieza SAE 3000 PSI



One piece 3000 PSI SAE Flange (45º Elbow)/ Code 61

Bride SAE coude 45º pré-sertie série 3000 PSI

Flangia 45º compatta SAE 3000 PSI



DN	∅	Referencia Part n°	€
1/2"	30.2	581840808	13,03
3/4"	38.1	581841212	22,66
1"	44.5	581841616	32,44
1"1/4	50.8	581842020	52,45
1"1/2	60.3	581842424	84,07
2"	71.4	581843232	147,14

Bridas 45º una sola pieza SAE 6000 PSI



One piece 6000 PSI SAE Flange (45º Elbow)/ Code 62

Bride SAE coude 45º pré-sertie série 6000 PSI

Flangia 45º compatta SAE 6000 PSI



DN	∅	Referencia Part n°	€
1/2"	31.8	582840808	15,22
3/4"	41.3	582841212	23,24
1"	47.6	582841616	33,97
1"1/4	54.0	582842020	54,64
1"1/2	63.5	582842424	88,89
2"	79.4	582843232	150,74

CONEXIONES UNA SOLA PIEZA SERIE BWS 3SP/4SP/R12/4SH NO PELAR

One piece fittings BWS SERIES 3SP/4SP/R12/4SH NO SKIVE

Embouts pré-sertis BWS 3SP/4SP/R12/4SH Sans dénuder

Raccordi compatti serie BWS R12/4SP/4SH Serie BW senza spellatura

Hembras giratorias rectas una sola pieza rosca BSP cono 60° con junta tórica **NEW**

One piece BSP female 60° cone +o'ring

Femelle pré-sertie BSP cone 60°+o'ring

Femmina diritta compatta BSP sede 60°+o'ring



DN	ROSCA THREAD	Referencia Part n°	€
3/4"	3/4" BSP	581101212	12,89
1"	1" BSP	581101616	20,36
1"1/4	1"1/4 BSP	581102020	38,54
1"1/2	1"1/2 BSP	581102424	60,53
2"	2" BSP	581103232	102,20

Hembras giratorias 90° una sola pieza rosca BSP cono 60° con junta tórica **NEW**

One piece BSP female cone 60° (90° Elbow) +o'ring

Coude 90° femelle pré-sertie BSP cone 60° +o'ring

Femmina 90° compatta BSP sede 60° +o'ring



DN	ROSCA THREAD	Referencia Part n°	€
3/8"	3/8" BSP	581170606	7,66
1/2"	1/2" BSP	581170808	10,35
5/8"	5/8" BSP	581171010	14,51
3/4"	3/4" BSP	581171212	19,62
1"	1" BSP	581171616	29,35
1"1/4	1"1/4 BSP	581172020	54,81
1"1/2	1"1/2 BSP	581172424	76,57
2"	2" BSP	581173232	158,93

Hembras giratorias 45° una sola pieza rosca BSP cono 60° con junta tórica **NEW**

One piece BSP female 60° cone (45° Elbow) +o'ring

Coude 45° femelle pré-sertie BSP cone 60° +o'ring

Femmina 45° compatta BSP sede 60° +o'ring



DN	ROSCA THREAD	Referencia Part n°	€
1"1/4	1"1/4 BSP	581182020	44,37
1"1/2	1"1/2 BSP	581182424	69,92
2"	2" BSP	581183232	111,30

Machos una sola pieza rosca cilíndrica BSP cono 60° **NEW**

One piece BSP male 60° cone

Mâle pré-serti BSP cone 60°

Maschio compatto cilindrico BSP sede 60°



DN	ROSCA THREAD	Referencia Part n°	€
3/8"	3/8" BSP	581120606	4,85
1/2"	1/2" BSP	581120808	6,34
3/4"	3/4" BSP	581121212	12,85
1"	1" BSP	581121616	17,94
1"1/4	1"1/4 BSP	581122020	41,04
1"1/2	1"1/2 BSP	581122424	58,29
2"	2" BSP	581123232	105,45

Hembras giratorias rectas una sola pieza rosca BSP cono 60° doble hexagonal **NEW**

One piece double hexagonal BSP female 60° cone

Femelle pré-sertie BSP cone 60° double hexagonal

Femmina diritta compatta BSP sede 60° doppio esagono



DN	ROSCA THREAD	Referencia Part n°	€
3/8"	3/8" BSP	584000606	6,25
1/2"	1/2" BSP	584000808	7,76
3/4"	3/4" BSP	584001212	17,04
1"	1" BSP	584001616	21,51
1"1/4	1"1/4 BSP	584002020	44,33
1"1/2	1"1/2 BSP	584002424	73,61
2"	2" BSP	584003232	122,73

Hembras giratorias rectas una sola pieza rosca BSP asiento plano **NEW**

One piece BSP female flat seat

Femelle pré-sertie BSP fond plat

Femmina diritta compatta BSP sede piana



DN	ROSCA THREAD	Referencia Part n°	€
3/8"	3/8" BSP	582000606	5,52
1/2"	1/2" BSP	582000808	6,30
3/4"	3/4" BSP	582001212	14,03
1"	1" BSP	582001616	19,29
1"1/4	1"1/4 BSP	582002020	39,98
1"1/2	1"1/2 BSP	582002424	63,16

CONEXIONES UNA SOLA PIEZA SERIE BWS 3SP/4SP/R12/4SH NO PELAR

One piece fittings BWS SERIES 3SP/4SP/R12/4SH NO SKIVE

Embouts pré-sertis BWS 3SP/4SP/R12/4SH Sans dénuder

Raccordi compatti serie BWS R12/4SP/4SH Serie BW senza spellatura

Hembras giratorias rectas una sola pieza rosca Métrica cono 24° - DKO



One piece Metric female cone 24°

Femelle pré-sertie Métrique cone 24°

Femmina diritta compatta Metrica sede 24°



DN	TUBO PIPE	SERIE SERIES	ROSCA THREAD	Referencia Part n°	€
3/8"	10	L	M16x1.5	58804161006	4,95
3/8"	12	L	M18x1.5	58804181206	4,82
3/8"	15	L	M22x1.5	58804221506	6,25
1/2"	15	L	M22x1.5	58804221508	6,27
1/2"	18	L	M26x1.5	58804261808	8,08
5/8"	18	L	M26x1.5	58804261810	8,63
3/4"	22	L	M30x2	58804302212	13,85
1"	28	L	M36x2	58804362816	21,03
1 1/4"	35	L	M45x2	58804453520	35,49
1 1/2"	42	L	M52x2	58804524224	59,23
3/8"	12	S	M20x1.5	58804201206	4,99
1/2"	16	S	M24x1.5	58804241608	7,26
5/8"	20	S	M30x2	58804302010	9,75
3/4"	20	S	M30x2	58804302012	14,43
3/4"	25	S	M36x2	58804362512	18,92
1"	30	S	M42x2	58804423016	25,47
1 1/4"	38	S	M45x2	58804523820	41,80

Hembras giratorias 90° una sola pieza Métricas cono 24° - DKO 90°



One piece Metric female cone 24° (90° Elbow)

Coude 90° femelle pré-sertie Métrique cone 24°

Femmina 90° compatta Metrica sede 24°



DN	TUBO PIPE	SERIE SERIES	ROSCA THREAD	Referencia Part n°	€
3/8"	10	L	M16x1.5	58305161006	6,29
3/8"	12	L	M18x1.5	58305181206	6,27
1/2"	15	L	M22x1.5	58305221508	8,33
5/8"	18	L	M26x1.5	58305261810	13,18
3/4"	22	L	M30x2	58305302212	18,96
1"	28	L	M36x2	58305362816	28,29
1 1/4"	35	L	M45x2	58305453520	50,81
1 1/2"	42	L	M52x2	58305524224	91,02
3/8"	15	S	M20x1.5	58305201206	6,03
1/2"	16	S	M24x1.5	58305241608	8,83
5/8"	20	S	M30x2	58305302010	14,62
3/4"	20	S	M30x2	58305302012	20,74
3/4"	25	S	M36x2	58305362512	24,29
1"	30	S	M42x2	58305423016	34,76
1 1/4"	38	S	M45x2	58305523820	63,22

Hembras giratorias 45° una sola pieza Métricas cono 24° - DKO 45°



One piece Metric female cone 24° (45° Elbow)

Coude 45° femelle pré-sertie Métrique cone 24°

Femmina 45° compatta Metrica sede 24°



DN	TUBO PIPE	SERIE SERIES	ROSCA THREAD	Referencia Part n°	€
3/8"	10	L	M16x1.5	58306161006	6,36
3/8"	12	L	M18x1.5	58306181206	5,94
1/2"	15	L	M22x1.5	58306221508	9,24
5/8"	18	L	M26x1.5	58306261810	13,52
3/4"	22	L	M30x2	58306302212	20,45
1"	28	L	M36x2	58306362816	29,05
1 1/4"	35	L	M45x2	58306453520	52,76
1 1/2"	24	L	M52x2	58306524224	87,26
3/8"	12	S	M20x1.5	58306201206	8,01
1/2"	16	S	M24x1.5	58306241608	9,51
5/8"	20	S	M30x2	58306302010	15,88
3/4"	20	S	M30x2	58306302012	20,68
3/4"	25	S	M36x2	58306362512	24,10
1"	30	S	M42x2	58306423016	34,22
1 1/4"	38	S	M45x2	58306523820	65,20

Machos una sola pieza rosca Métrica cono 24°



One piece Metric male cone 24°

Mâle pré-serti Métrique cone 24°

Maschio compatto Metrico sede 24°



DN	TUBO PIPE	SERIE SERIES	ROSCA THREAD	Referencia Part n°	€
3/8"	10	L	M16x1.5	58203161006	4,58
3/8"	12	L	M18x1.5	58203181206	4,42
3/8"	15	L	M22x1.5	58203221506	5,89
1/2"	15	L	M22x1.5	58203221508	6,42
1/2"	18	L	M26x1.5	58203261808	7,44
5/8"	18	L	M26x1.5	58203261810	8,17
3/4"	22	L	M30x2	58203302212	13,47
1"	28	L	M36x2	58203362816	20,94
1 1/4"	35	L	M45x2	58203453520	36,25
1 1/2"	42	L	M52x2	58203524224	61,12
3/8"	12	S	M20x1.5	58203201206	5,38
1/2"	16	S	M24x1.5	58203241608	7,03
5/8"	20	S	M30x2	58203302010	10,46
3/4"	20	S	M30x2	58203302012	14,41
3/4"	25	S	M36x2	58203362512	18,94
1"	30	S	M42x2	58203423016	26,08
1 1/4"	38	S	M45x2	58203523820	43,66

BWS

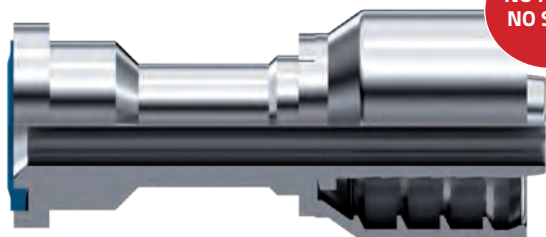

**NO PELAR
NO SKIVE**



MAYOR VERSATILIDAD. 1 CASQUILLO - 4 MANGUERAS
GREATER VERSATILITY. 1 FERRULE - 4 HOSES

+



REDUCCIÓN DE STOCK. USO DE ESPIGA STD
STOCK OPTIMISATION. STD SERIES

+



MENOR TIEMPO DE MONTAJE. NO PELAR
REDUCES ASSEMBLY TIME. NO SKIVE

=



AHORRO ECONÓMICO.
ECONOMIC EFFICIENCY



BW+

NEW



**NO PELAR
NO SKIVE**



ALTA PRESIÓN
HIGH PRESSURE

1" 1/4 - 1" 1/2-2

R13 - R15

+



REDUCCIÓN DE STOCK. USO DE ESPIGA BW
STOCK OPTIMISATION. BW SERIES

+



MENOR TIEMPO DE MONTAJE. NO PELAR
REDUCES ASSEMBLY TIME. NO SKIVE



CONEXIONES UNA PIEZA SERIE BW+ R13/R15 NO PELAR

One piece fittings BW+ Series R13/R15 No Skive
 Embouts R13/R15 Série BW+ Sans denuder
 Raccordi R13/R15 Serie BW+ senza spellatura

R13 & R15 - Ø 3/4" - 1" BWS

Hembras giratorias rectas una sola pieza JIC 37º doble hexagonal

One piece double hexagonal JIC 37º Swivel female

Femelle pré-sertie JIC 37º double hexagonal

Femmina diritta compatta JIC 37º doppio esagono



DN	ROSCA THREAD	Referencia Part nº	€
1" 1/4	1" 5/8 12 UNF	692422620	*
1" 1/2	1" 7/8 12 UNF	692423024	*
2"	2" 1/2 12 UNF	692424032	*

Hembras giratorias 90º una sola pieza ORFS

One piece ORFS Swivel female (90º Elbow)

Coude 90º femelle pré-sertie ORFS

Femmina 90º compatta ORFS



DN	ROSCA THREAD	Referencia Part nº	€
1" 1/4	1" 11/16 12 UNF	699072020	*
1" 1/2	2" 12 UNF	699072424	*

Hembras giratorias 90º una sola pieza rosca JIC 37º

One piece JIC 37º Swivel female (90º Elbow)

Coude 90º femelle pré-sertie JIC 37º

Femmina gir. compatta 90º JIC 37º



DN	ROSCA THREAD	Referencia Part nº	€
1" 1/4	1" 5/8 12 UNF	691382620	*
1" 1/2	1" 7/8 12 UNF	691383024	*
2"	2" 1/2 12 UNF	691384032	*

Hembras giratorias 45º una sola pieza ORFS

One piece ORFS Swivel female (45º Elbow)

Coude 45º femelle pré-sertie ORFS

Femmina 45º compatta ORFS



DN	ROSCA THREAD	Referencia Part nº	€
1" 1/4	1" 11/16 12 UNF	699082020	*
1" 1/2	2" 12 UNF	699082424	*

Hembras giratorias 45º una sola pieza rosca JIC 37º

One piece JIC 37º Swivel female (45º Elbow)

Coude 45º femelle pré-sertie JIC 37º

Femmina gir. compatta 45º JIC 37º



DN	ROSCA THREAD	Referencia Part nº	€
1" 1/4	1" 5/8 12 UNF	691392620	*
1" 1/2	1" 7/8 12 UNF	691393024	*
2"	2" 1/2 12 UNF	691394032	*

Machos una sola pieza rosca JIC 37º C/J

One piece JIC 37º male with o'ring

Mâle pré-serti JIC 37º avec joint torique

Maschio compatto JIC 37º con o'ring



DN	ROSCA THREAD	Referencia Part nº	€
1" 1/4	1" 5/8 12 UNF	691402620	*
1" 1/2	1" 7/8 12 UNF	691403024	*
2"	2" 1/2 12 UNF	691404032	*

Hembras giratorias rectas una sola pieza ORFS doble hexagonal

One piece ORFS Swivel female straight double hexagonal

Femelle pré-sertie droite ORFS double hexagonale

Femmina diritta compatta ORFS doppio esagono



DN	ROSCA THREAD	Referencia Part nº	€
1" 1/4	1" 11/16 12 UNF	699012020	*
1" 1/2	2" 12 UNF	699012424	*

*Consultar / On request / Sur demande / Su richiesta

CONEXIONES UNA PIEZA SERIE BW+ R13/R15 NO PELAR

One piece fittings BW+ Series R13/R15 No Skive
 Embouts R13/R15 Série BW+ Sans denuder
 Raccordi R13/R15 Serie BW+ senza spellatura

Bridas recta SAE 6000 PSI



One piece 6000 PSI SAE Straight Flange / Code 62

Bride SAE droite pré-sertie série 6000 PSI

Flangia diritta compatta SAE 6000



DN	∅	Referencia Part n°	€
1"1/4	1"1/4	692822020	*
1"1/2	1"1/2	692822424	*
2"	2"	692823232	*

Bridas a 90° SAE 6000 PSI



One piece 6000 PSI SAE Flange (90° Elbow) / Code 62

Bride SAE coude 90° pré-sertie série 6000 PSI

Flangia 90° compatta SAE 6000



DN	∅	Referencia Part n°	€
1"1/4	1"1/4	692832020	*
1"1/2	1"1/2	692832424	*
2"	2"	692833232	*

Bridas a 45° SAE 6000 PSI



One piece 6000 PSI SAE Flange (45° Elbow) / Code 62

Bride SAE coude 45° pré-sertie série 6000 PSI

Flangia 45° compatta SAE 6000



DN	∅	Referencia Part n°	€
1"1/4	1"1/4	692842020	*
1"1/2	1"1/2	692842424	*
2"	2"	692843232	*

Machos cilíndricos una sola pieza BSP 60°



One piece BSP Male 60° cone

Mâle pré-serti gaz cylindrique BSP 60°

Maschio compatto BSP cilindrico sede 60°



DN	ROSCA THREAD	Referencia Part n°	€
1"1/4	1"1/4 BSP	691122020	*
1"1/2	1"1/2 BSP	691122424	*
2"	2" BSP	691123232	*

Hembras giratorias una sóla pieza BSP 60° con junta



One piece BSP Swivel female cone 60° with o'ring

Femelle BSP pré-sertie cone 60° with o'ring

Femmina diritta compatta BSP sede 60° con guarnizione



DN	ROSCA THREAD	Referencia Part n°	€
1" 1/4	1" 1/4	691102020	*
1" 1/2	1" 1/2	691102424	*
2"	2" BSP	691103232	*

Hembras giratorias 90° una sola pieza BSP 60° C/J



One piece BSP Swivel female 60° cone with o'ring (90° Elbow)

Coude 90° femelle pré-sertie BSP 60° avec o'ring

Femmina 90° compatta BSP sede 60° con o'ring



DN	ROSCA THREAD	Referencia Part n°	€
1"1/4	1"1/4 BSP	691172020	*
1"1/2"	1"1/2 BSP	691172424	*
2"	2" BSP	691173232	*

Hembras giratorias 45° una sola pieza BSP 60° C/J



One piece BSP Swivel female 60° cone with o'ring (45° Elbow)

Coude 45° femelle pré-sertie BSP 60° avec o'ring

Femmina 45° compatta BSP sede 60° con o'ring



DN	ROSCA THREAD	Referencia Part n°	€
1"1/4	1"1/4 BSP	691182020	*
1"1/2	1"1/2 BSP	691182424	*
2"	2" BSP	691183232	*

*Consultar / On request / Sur demande / Su richiesta

CONEXIONES PUSH ON

PUSH ON series fittings

Embouts PUSH ON

Raccordi serie PUSH ON

Hembras giratorias rectas rosca BSP cono 60°

NEW

BSP Swivel female 60° cone

Femelle tournante gaz cyl BSP 60°

Femmina diritta BSP sede 60°



DN	ROSCA THREAD	Referencia Part n°	€
1/4"	1/4" BSP	391000404	3,22
3/8"	3/8" BSP	391000606	3,72
1/2"	1/2" BSP	391000808	5,45
5/8"	5/8" BSP	391001010	7,02
3/4"	3/4" BSP	391001212	8,50
1"	1" BSP	391001616	16,10

Machos BSP 60°

NEW

BSP Male 60° cone

Mâle BSP cône 60°

Maschio BSP 60°



DN	ROSCA THREAD	Referencia Part n°	€
1/4"	1/4" BSP	391120404	3,55
3/8"	3/8" BSP	391120606	4,62
1/2"	1/2" BSP	391120808	6,52
5/8"	5/8" BSP	391121010	9,82
3/4"	3/4" BSP	391121212	10,15
1"	1" BSP	391121616	19,73

Hembras giratorias rectas JIC 37°

NEW

JIC Swivel female 37° cone

Femelle tournante droite JIC cône 37°

Femmina diritta JIC 37°

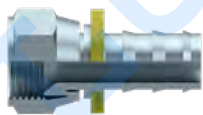

DN	ROSCA THREAD	Referencia Part n°	€
1/4"	7/16" 20 UNF	391420704	3,05
3/8"	9/16" 18 UNF	391420906	3,47
1/2"	3/4" 16 UNF	391421208	5,20
5/8"	7/8" 14 UNF	391421410	6,36
3/4"	1"1/16 12 UN	391421712	8,09
1"	1"5/16 12 UN	391422116	15,35

Machos JIC 37°

NEW

JIC 37° Male

Mâle JIC 37°

Maschio 37°

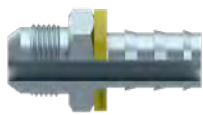

DN DN	ROSCA	Referencia Part n°	€
1/4"	7/16" 20 UNF	391400704	3,05
3/8"	9/16" 18 UNF	391400906	3,55
1/2"	3/4" 16 UNF	391401208	4,54
5/8"	7/8" 14 UNF	391401410	5,86
3/4"	1"1/16 12 UN	391401712	7,51
1"	1"5/16 12 UN	391402116	14,45

Machos rosca NPT

NEW

NPT Male

Mâle fixe NPT

Maschio conico NPT



DN	ROSCA THREAD	Referencia Part n°	€
1/4"	1/4" NPT	391610404	3,14
3/8"	3/8" NPT	391610606	3,72
1/2"	1/2" NPT	391610808	4,79
3/4"	3/4" NPT	391611212	8,17

Hembras giratorias rectas 24°

NEW

Metric Swivel female 24° cone

Femelle tournante droite 24°

Femmina diritta 24°



DN	TUBO PIPE	SERIE SERIES	ROSCA THREAD	Referencia Part n°	€
1/4"	8	L	M14X1.5	39804140804	3,22
3/8"	12	L	M18X1.5	39804181206	4,54
1/2"	15	L	M22X1.5	39804221508	6,52
3/4"	22	L	M30X2	39804302212	10,57

Machos rosca métrica 24°

NEW

24° Cone Male

Mâle fixe 24°

Maschio conico 24°



DN	TUBO PIPE	SERIE SERIES	ROSCA THREAD	Referencia Part n°	€
1/4"	8	L	M14X1.5	39203140804	3,14
3/8"	12	L	M18X1.5	39203181206	4,05
1/2"	22	L	M22X1.5	39203221508	5,61
3/4"	30	L	M30X2	39203302212	9,99